

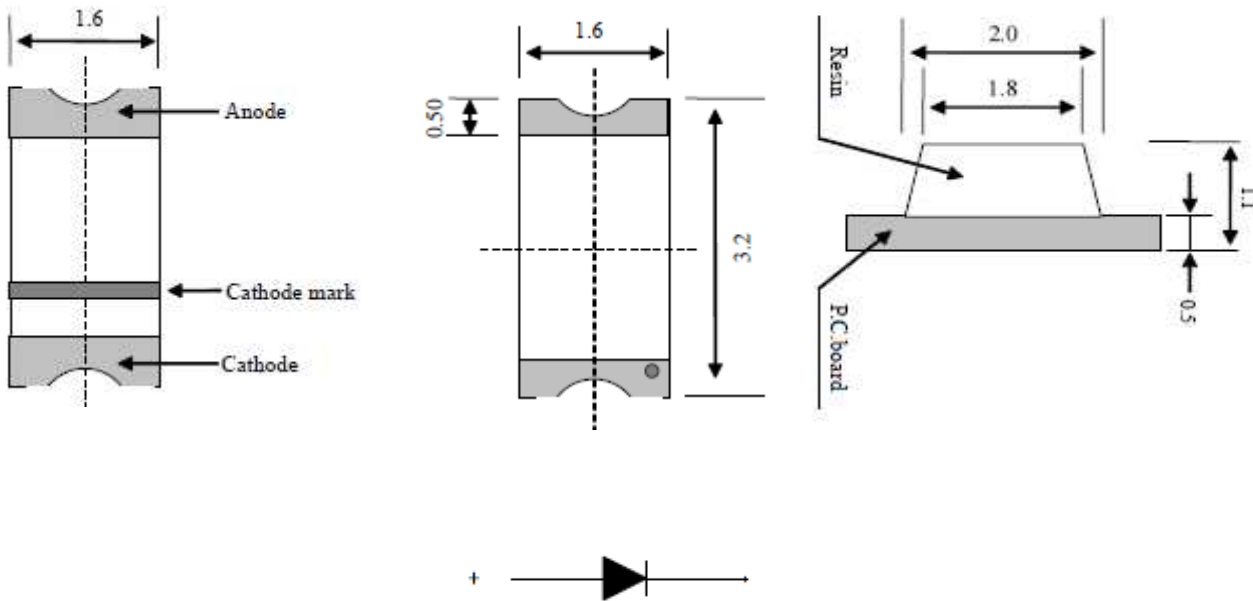

Applications

- Interior automotive lighting(dashboard backlight etc...)
- Optical indicators
- High Tech Lightning
- Security Parts
- Automotive Products

Package Dimensions (Tol. +/- 0,10mm)



Recommend Soldering Pad Dimensions (Tol. +/- 0,10mm)

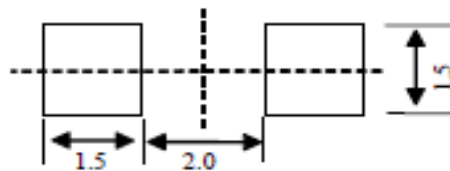

Notes:					CHIP LED FOR REVERSE PCB MOUNTING		
All dimensions in mm tolerance is ± 0.1 mm unless otherwise noted.							
					Part.No.	M11B9017	
					Customer		
DRW:	Harry	CHKD	Dustin	Tolerance	Tolerance:	Date:	05.11.2013
APPD:	Jason	MATL	Wilson	John	MASON	Sheet No.	1 from 6

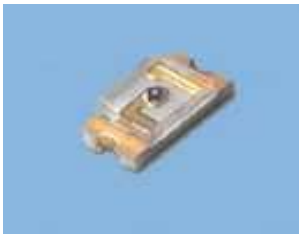

Absolute Maximum Ratings (Ta = 25°C)

Item-Disription	Symbol	Value	Unit
DC Forward Current	PD	60	mW
Pulse Forward Current	IFP	70	mA
Forward Current:	IFP	25	mA
Reverse Voltage:	VR	5	V
Electrostatic Discharge:	ESD	2000	V
Operating Voltage	Topr	.-20 ~ +85	°C
Storage Temperature	Tstg	.-30 ~ +100	°C
Lead Soldering Temp.	Tsol	260°C/5Sec.	---

Typical Electrical & Optical Characteristics (IF=20mA and Ta = 25°C)

Item	Symbol	Condition	Min.	Typ.	Max.	Unit
Luminious Intensity:	Iv	IF=20mA		100		mcd
Viewing Angle:	20 1/2	IF=20mA		125		Deg.
Peak Emission Wave.:	λ_p	IF=20mA				nm
Domi. Wavelength:	λ_d	IF=20mA	585	590		nm
Spectral Line Half-Width:	$\Delta\lambda$	IF=20mA		30		nm
DC Forward Voltage:	Vf	IF=20mA		2,00	2,50	V
DC Reverse Voltage:	Ir	Vr=5V			10	μ A
Color Temperature: (White)		IF=20mA				K
Chromaticity (White)	X	IF=20mA				
Coordinates: (White)	Y	IF=20mA				

Notes:					CHIP LED FOR REVERSE PCB MOUNTING		
1. Tolerance of measurement of luminous intensity				: \pm 10%	Part.No.	M11B9017	
2. Tolerance of measurement of chromatic coordinates			: \pm 1nm				
3. Tolerance of measurement of forward voltage			: \pm 0.1V				
					Customer		
DRW:	Harry	CHKD	Dustin	Tolerance	Tolerance:	Date:	05.11.2013
APPD:	Jason	MATL	Wilson	John	MASON	Sheet No.	2 from 6



Diagramm of viewing angle



Diagramm of LED

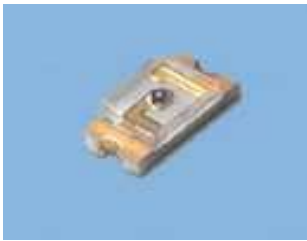

CHIP LED FOR REVERSE PCB MOUNTING

Part.No.	M11B9017
Customer	

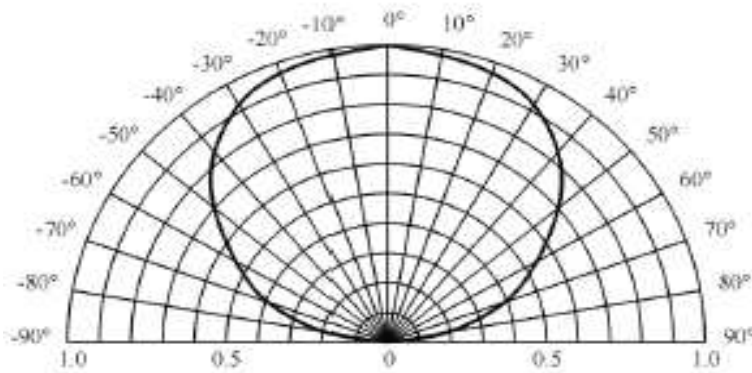
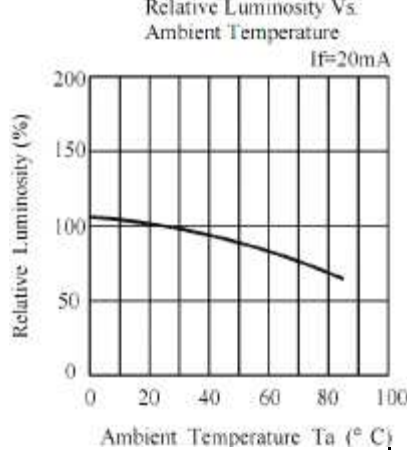
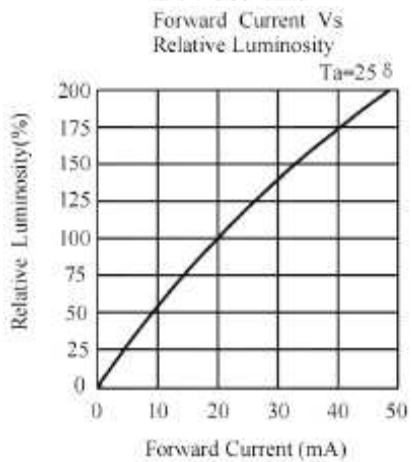
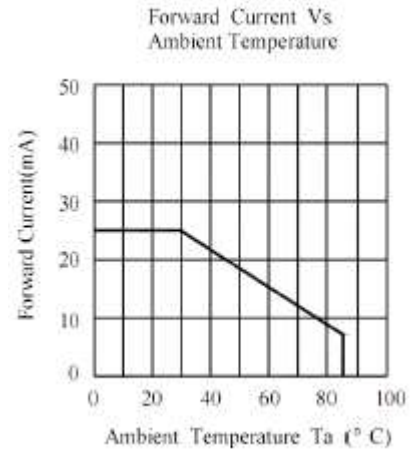
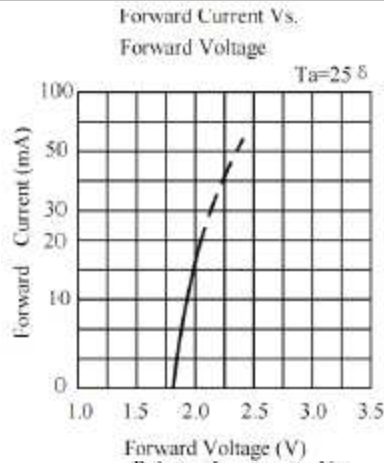
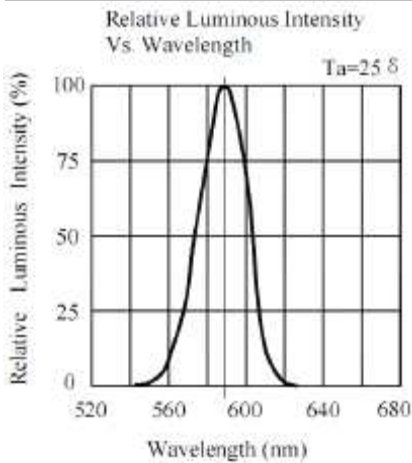
DRW:	Harry	CHKD	Dustin	Tolerance	Tolerance:	Date:	05.11.2013
APPD:	Jason	MATL	Wilson	John	MASON	Sheet No.	3 from 6

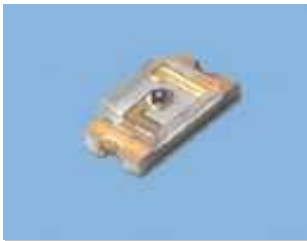

Soldering condition for Lead solder

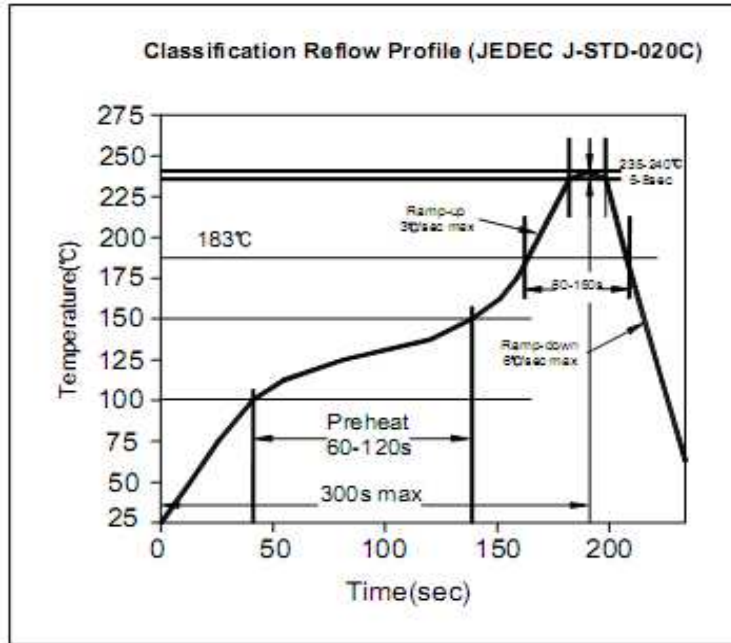

Soldering condition for Lead free solder

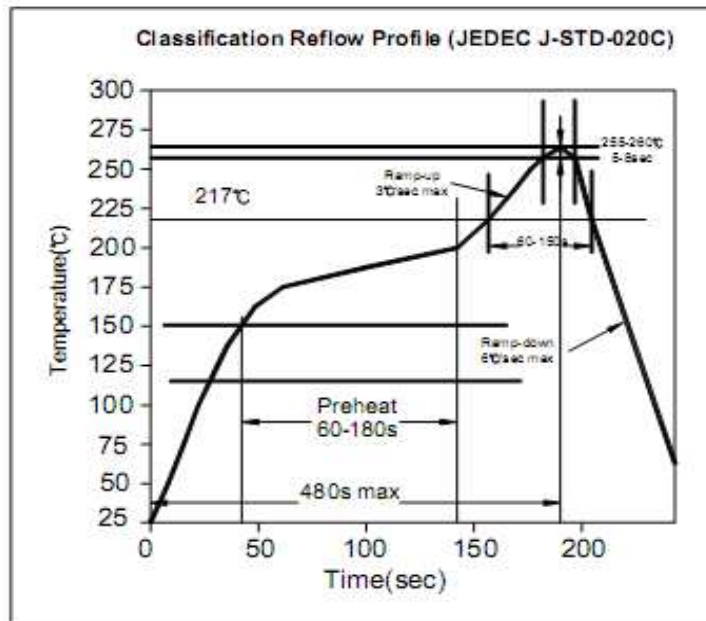

CHIP LED FOR REVERSE PCB MOUNTING

Part.No.	M11B9017
Customer	

DRW:	Harry	CHKD	Dustin	Tolerance	Tolerance:	Date:	05.11.2013
APPD:	Jason	MATL	Wilson	John	MASON	Sheet No.	4 from 6



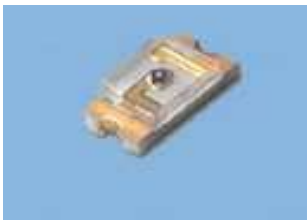

Packing specification (Antistatic Poly Bag)

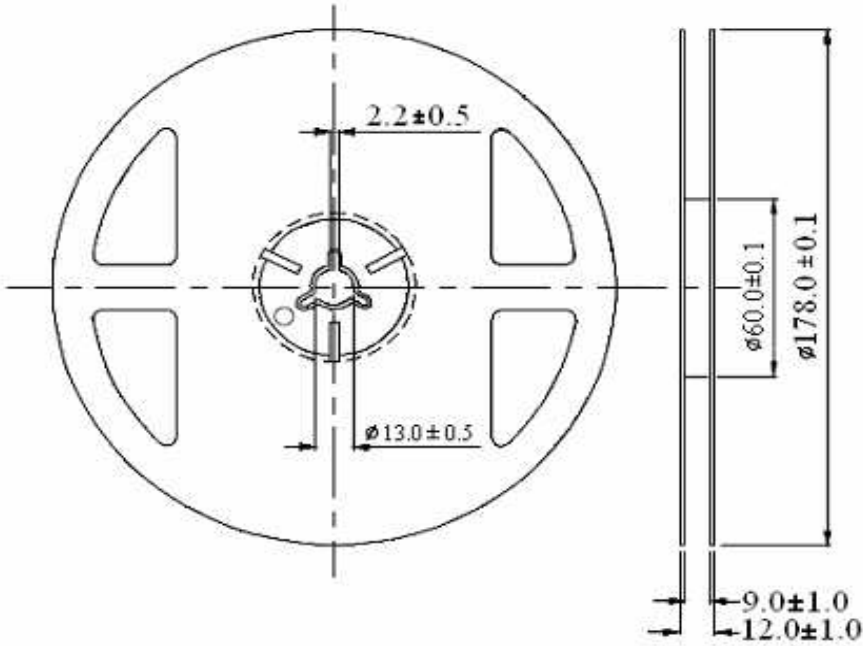

Unit: mm
Tolerance: ± 0.25mm

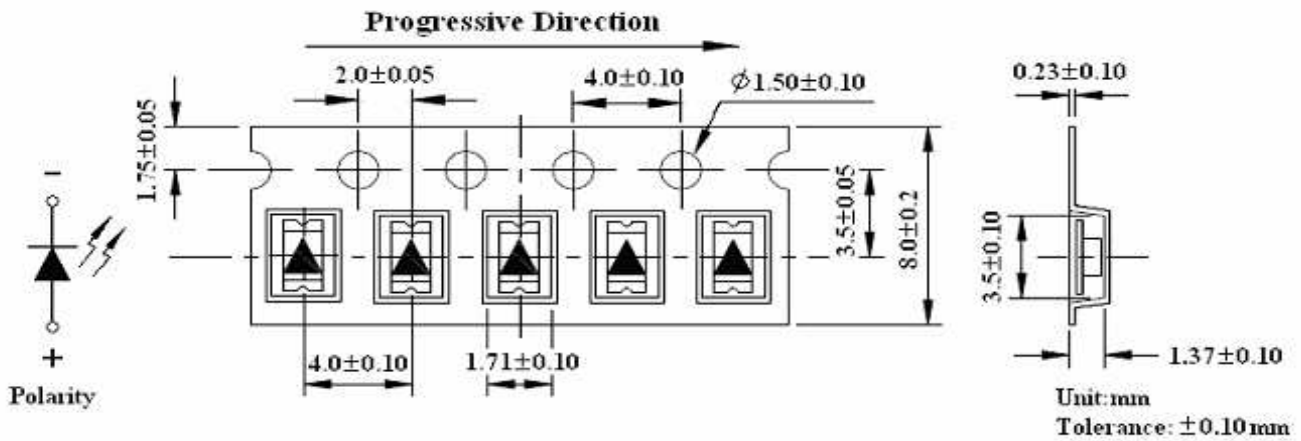

Unit: mm
Tolerance: ± 0.10mm



Quantity of Reel (2000PCS Normal) other Packing Specifications available					CHIP LED FOR REVERSE PCB MOUNTING		
					Part.No.	M11B9017	
Customer							

DRW:	Harry	CHKD	Dustin	Tolerance	Tolerance:	Date:	05.11.2013
APPD:	Jason	MATL	Wilson	John	MASON	Sheet No.	5 from 6

www.edcon-components.com

email: info@edcon-components.com

Copyright by S.Tiede





Color table curve

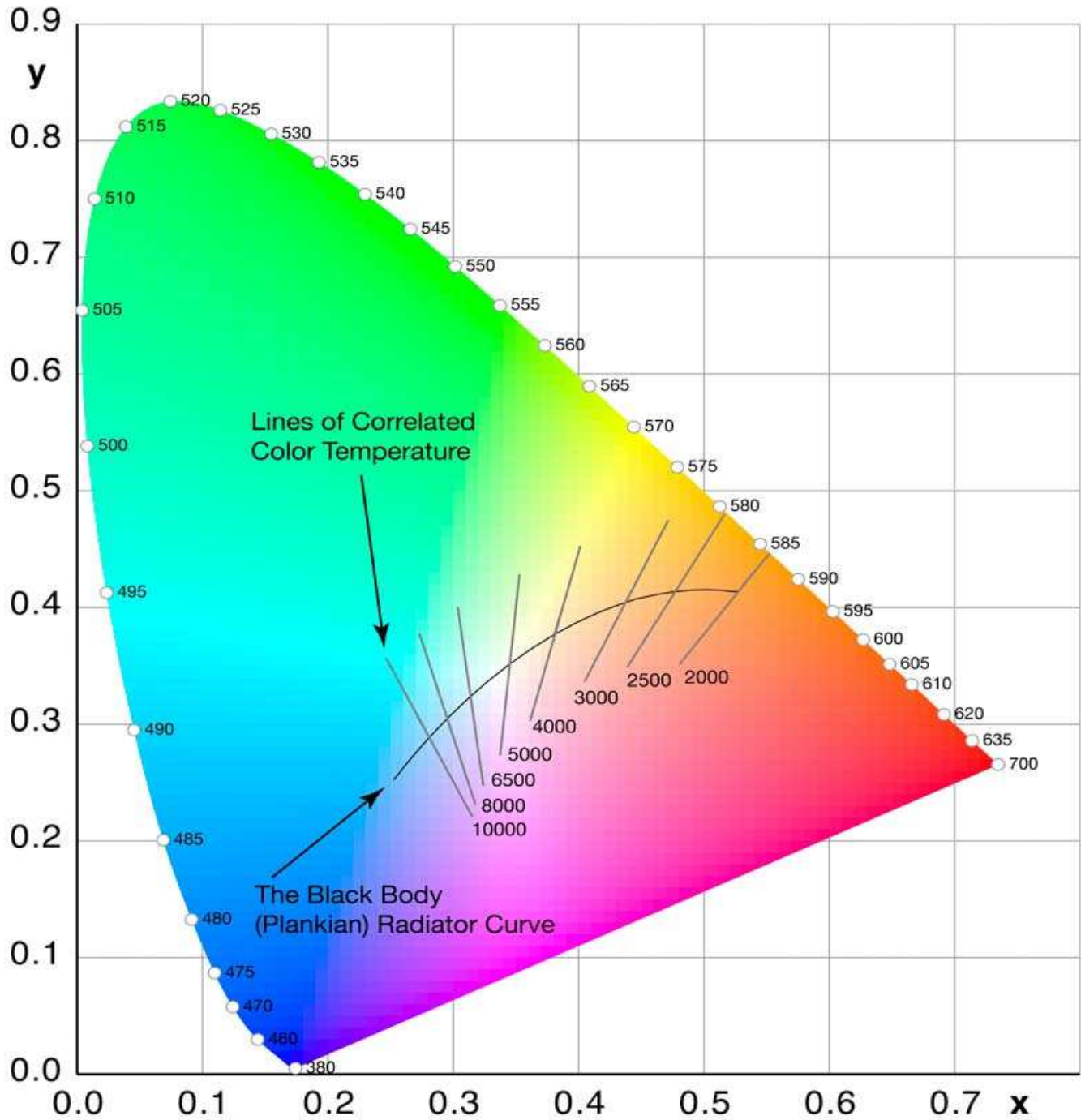

CHIP LED LED FOR REVERSE PCB MOUNTING	
Part.No.	M11B9017
Customer	

DRW:	Harry	CHKD	Dustin	Tolerance	Tolerance:	Date:	05.11.2013
APPD:	Jason	MATL	Wilson	John	MASON	Sheet No.	6 from 6