

EDCON-COMPONENTS

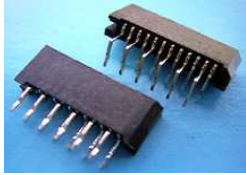

Material

Housing: Nylon46 UL94V-0
Terminal: Phosphor Bronze

Dimension

DIM A = 1.25 * (CKT-1)
DIM B = DIM A + 2.6mm
DIM C = DIM A + 4.0mm

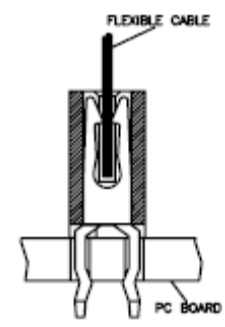
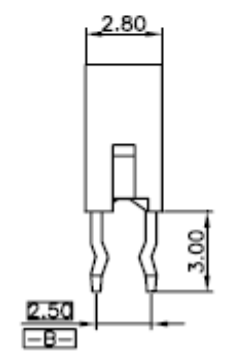
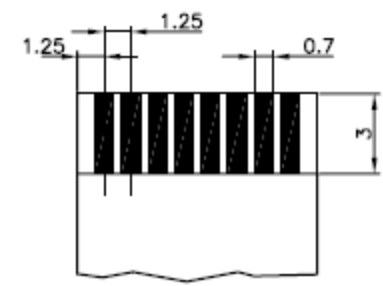
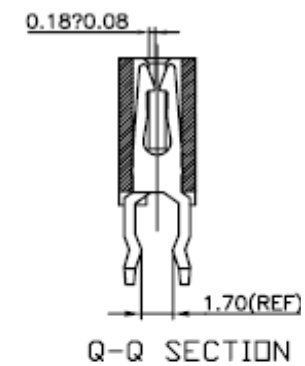
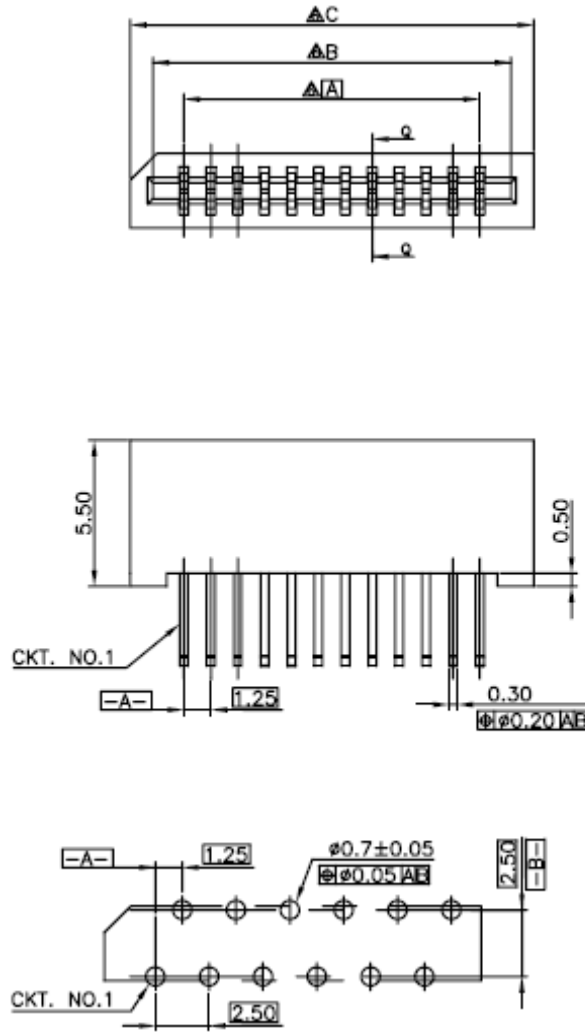

Non-Zif FPC / FFC Connector
Pitch: 1.25mm

Part No.: T28E013

DRW:	Jason	CHKD	Wilson	MATL:	Wilson	TOLERANCE	Mason	DATE	12.07.2010	Customer:
APPD:	Schumi			FINISH	Jamy		Sheet No.	1 from 2		

EDCON-COMPONENTS

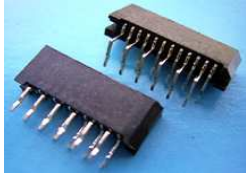

Ordering Information

Serie	-	Number of Contact	Contact Plating	Insulator Color	Packing Style					
T28E013	-	3	T	1	TU					
EDCON-Serie	-	03 = 3 Con. ... 32 = 32 Con.	T = Tin Plated G = Flash Gold	1 = Black (Standard) 2 = Ivory	TU = Tube (Standard) TR = Tape Reel (on Request)					

Soldering Profile Curve

Classification Reflow Profile (JEDEC J-STD-020C)

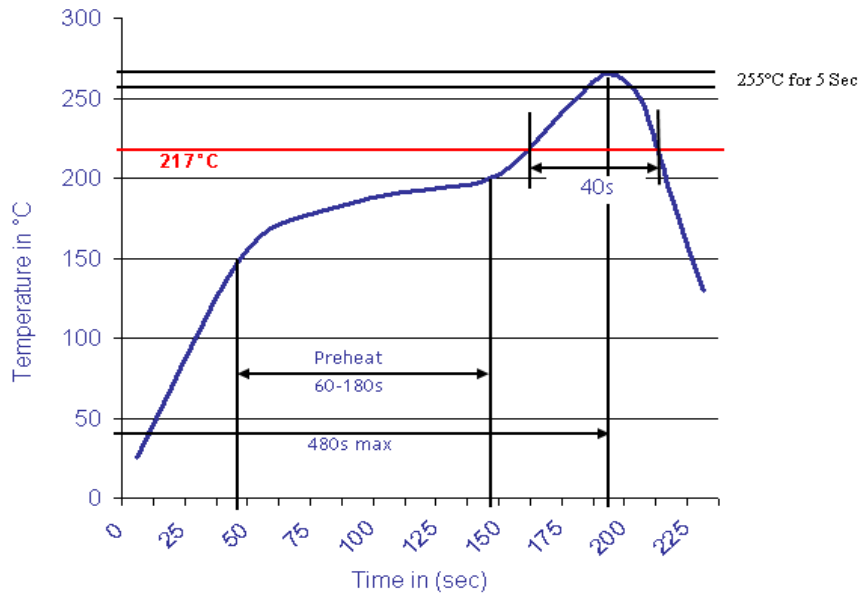

Non-Zif FPC / FFC Connector	
Pitch: 1.25mm	
Part No.:	T28E013

DRW:	Jason	CHKD	Wilson	MATL:	Wilson	TOLERANCE	Mason	DATE	12.07.2010	Customer:
APPD:	Schumi			FINISH	Jamy		Sheet No.	2 from 2		