

EDCON-COMPONENTS

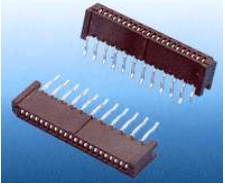

Material

Housing: Nylon46 UL94V-0
Terminal: Phosphor Bronze

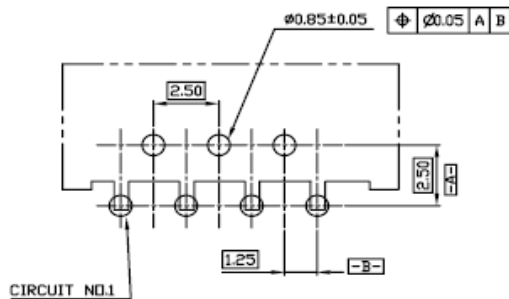
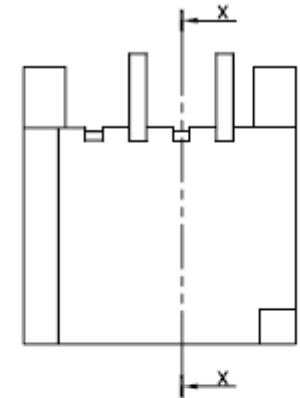
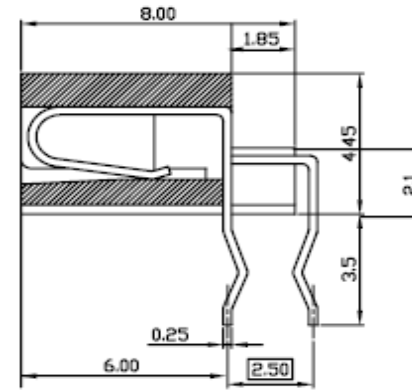
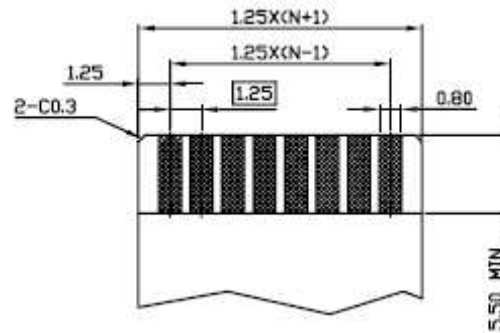

CKT	A	B	C	CKT	A	B	C
3	7.15	5.10	2.50	18	25.90	23.85	21.25
4	8.40	6.35	3.75	19	27.15	25.10	22.50
5	9.65	7.60	5.00	20	28.40	26.35	23.75
6	10.90	8.85	6.25	21	29.65	27.60	25.00
7	12.15	10.10	7.50	22	30.90	28.85	26.25
8	13.40	11.35	8.75	23	32.15	30.10	27.50
9	14.65	12.60	10.00	24	33.40	31.35	28.75
10	15.90	13.85	11.25	25	34.65	32.60	30.00
11	17.15	15.10	12.50	26	35.90	33.85	31.25
12	18.40	16.35	13.75	27	37.15	35.10	32.50
13	19.65	17.60	15.00	28	38.40	36.35	33.75
14	20.90	18.85	16.25	29	39.65	37.60	35.00
15	22.15	20.10	17.50	30	40.90	38.85	36.25
16	23.40	21.35	18.75	31	42.15	40.10	37.50
17	24.65	22.60	20.00	32	43.40	41.35	38.75

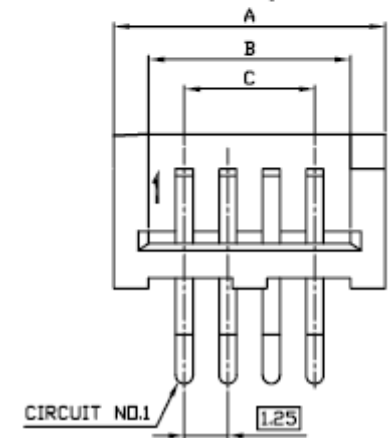

Non-Zif FPC / FFC Connector
Pitch: 1.25mm

Part No.: **T28E008**

DRW:	Jason	CHKD	Wilson	MATL:	Wilson	TOLERANCE	Mason	DATE	12.07.2010	Customer:
APPD:	Schumi			FINISH	Jamy		Sheet No.	1 from 2		

EDCON-COMPONENTS

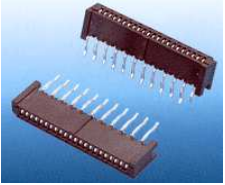

Ordering Information

Serie	-	Number of Contact	Contact Plating	Insulator Color	Packing Style					
T28E008	-	3	T	3	TU					
EDCON-Serie	-	03 = 3 Con. ... 32 = 32 Con.	T = Tin Plated G = Flash Gold	3 = Red (Standard) 2 = Ivory 1 = Black	TU = Tube (Standard) TR = Tape Reel (on Request)					

Soldering Profile Curve

Classification Reflow Profile (JEDEC J-STD-020C)

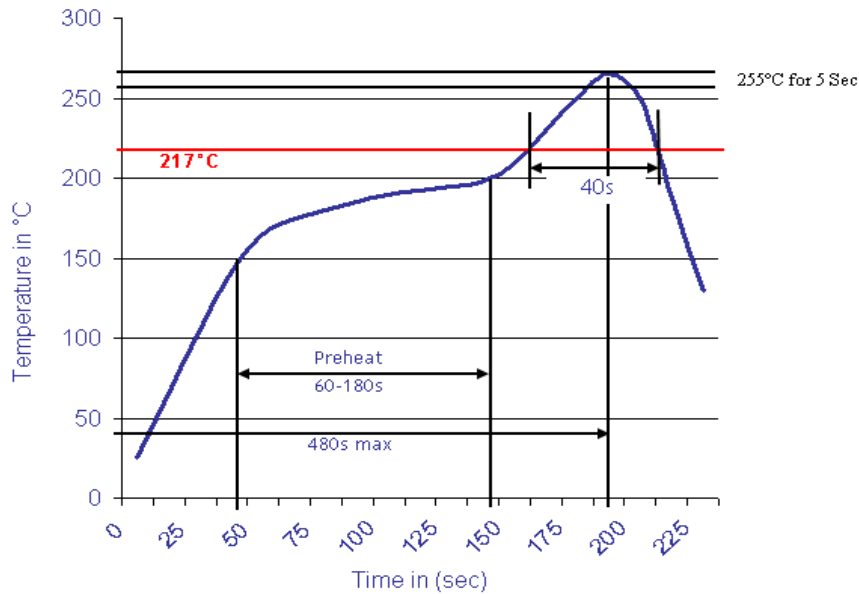

Non-Zif FPC / FFC Connector	
Pitch: 1.25mm	
Part No.:	T28E008

DRW:	Jason	CHKD	Wilson	MATL:	Wilson	TOLERANCE	Mason	DATE	12.07.2010	Customer:
APPD:	Schumi			FINISH	Jamy		Sheet No.	2 from 2		