

EDCON-COMPONENTS

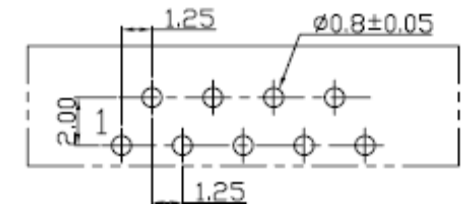

Material

Housing: PBT UL94V-0
Terminal: Phosphor Bronze

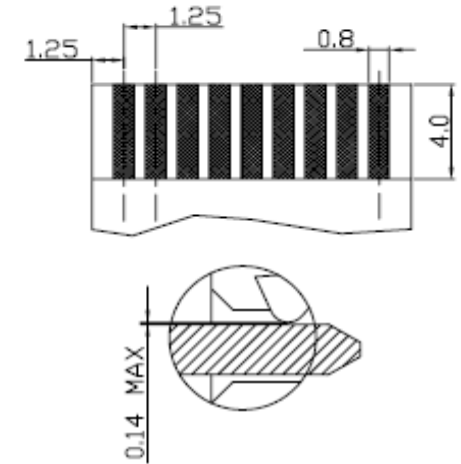
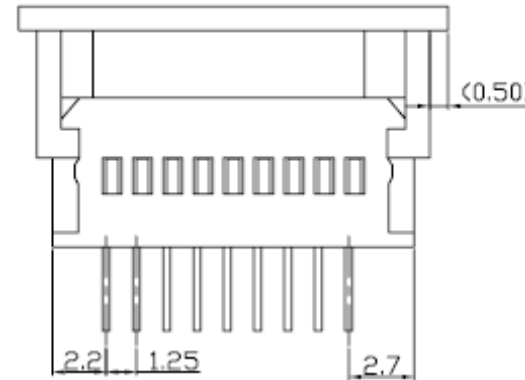
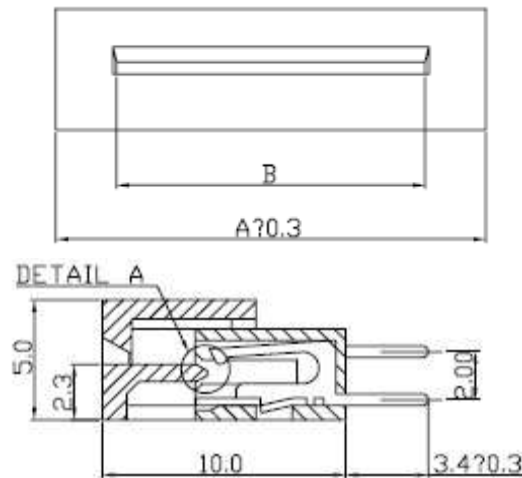

CKT	A	B	CKT	A	B
3	9.55	5.20	18	28.30	23.95
4	10.80	6.45	19	29.55	25.20
5	12.05	7.70	20	30.80	26.45
6	13.30	8.95	21	32.05	27.70
7	14.55	10.20	22	33.30	28.95
8	15.80	11.45	23	34.55	30.20
9	17.05	12.70	24	35.80	31.45
10	18.30	13.95	25	37.05	32.70
11	19.55	15.20	26	38.30	33.95
12	20.80	16.45	27	39.55	35.20
13	22.05	17.70	28	40.80	36.45
14	23.30	18.95	29	42.05	37.70
15	24.55	20.20	30	43.30	38.95
16	25.80	21.45	31	44.55	40.20
17	27.05	22.70	32	45.80	41.45

Non-Zif FPC / FFC Connector
Pitch: 1.25mm

Part No.: **T28E004**

DRW:	Jason	CHKD	Wilson	MATL:	Wilson	TOLERANCE	Mason	DATE	12.07.2010	Customer:
APPD:	Schumi			FINISH	Jamy		Sheet No.	1 from 2		



Ordering Information

Serie	-	Number of Contact	Contact Plating	Insulator Color	Packing Style					
T28E004	-	2	T	2	TU					
EDCON-Serie	-	03 = 3 Con. ... 32 = 32 Con.	T = Tin Plated G = Flash Gold	2 = Ivory (Standard) 1 = Black	TU = Tube (Standard) TR = Tape Reel (on Request)					

Soldering Profile Curve

Classification Reflow Profile (JEDEC J-STD-020C)

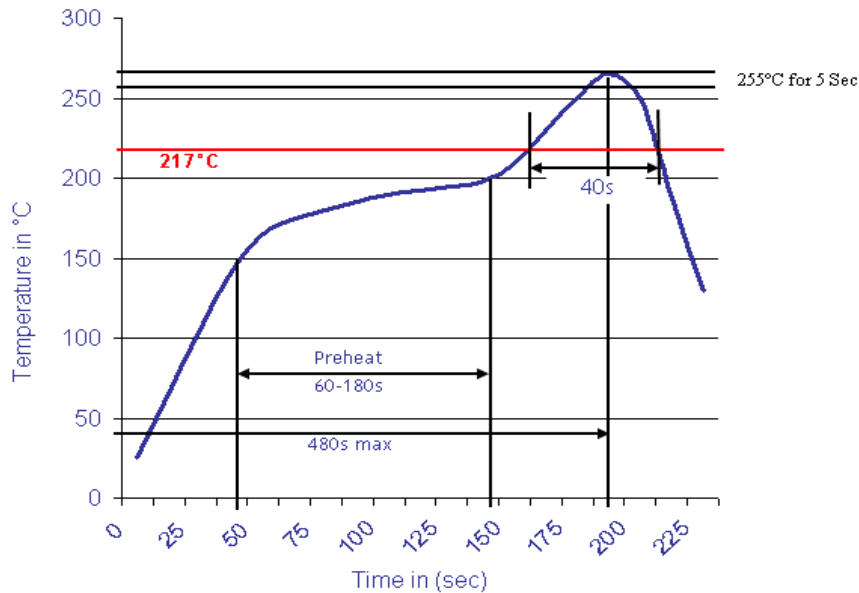

Non-Zif FPC / FFC Connector Pitch: 1.25mm	
Part No.:	T28E004

DRW:	Jason	CHKD	Wilson	MATL:	Wilson	TOLERANCE	Mason	DATE	12.07.2010	Customer:
APPD:	Schumi			FINISH	Jamy		Sheet No.	2 from 2		