

## Schottky Barrier Diode

### Features

1. Saving space
2. High reliability
3. Low reverse current and low forward voltage
4. Micro Melf package, fits onto SOD 323/SOT 23 footprints



### Applications

Low current rectification and high speed switching

### Construction

Silicon epitaxial planar

### Absolute Maximum Ratings

$T_j=25^{\circ}\text{C}$

Parameter	Test Conditions	Type	Symbol	Value	Unit
Repetitive peak reverse voltage		MCL103A	$V_{RRM}$	40	V
		MCL103B	$V_{RRM}$	30	V
		MCL103C	$V_{RRM}$	20	V
Repetitive peak forward current	$t_p \leq 1 \text{ s}$		$I_{FRM}$	1	A
Forward current			$I_{FM}$	350	mA
Power dissipation	$T_{amb}=25^{\circ}\text{C}$		$P_V$	400	mW
Storage temperature range			$T_{stg}$	-65~+175	$^{\circ}\text{C}$

### Maximum Thermal Resistance

$T_j=25^{\circ}\text{C}$

Parameter	Test Conditions	Symbol	Value	Unit
Junction ambient	on PC board 50mm×50mm×1.6mm	$R_{thJA}$	250	K/W

## Electrical Characteristics

$T_j=25^\circ\text{C}$

Parameter	Test Conditions	Type	Symbol	Min	Typ	Max	Unit
Forward voltage	$I_F=20\text{mA}$		$V_F$			0.37	V
	$I_F=200\text{mA}$		$V_F$			0.6	V
Reverse current	$V_R=30\text{V}$	MCL103A	$I_R$			5	$\mu\text{A}$
	$V_R=20\text{V}$	MCL103B	$I_R$			5	$\mu\text{A}$
	$V_R=10\text{V}$	MCL103C	$I_R$			5	$\mu\text{A}$
Diode capacitance	$V_R=V_F=0, f=1\text{MHz}$		$C_D$		50		pF
Reverse recovery time	$I_F=I_R=200\text{mA to }0.1\text{mA } I_R$		$t_{rr}$		10		ns

## Characteristics ( $T_j=25^\circ\text{C}$ unless otherwise specified)

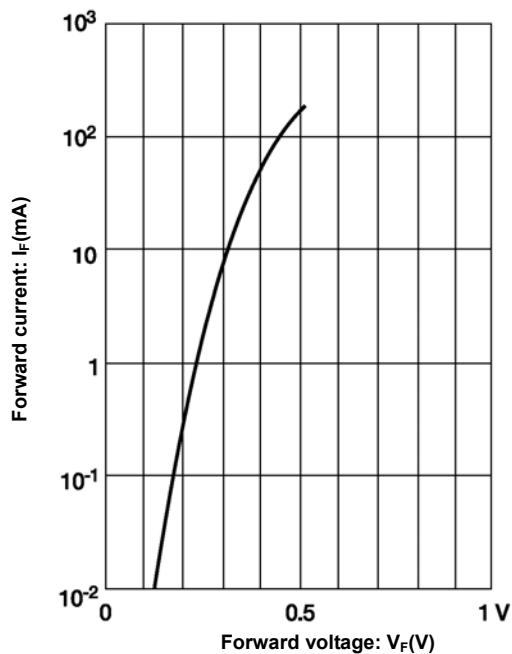

Figure 1. Typical variation of forward current vs. forward voltage for primary conduction through the schottky barrier

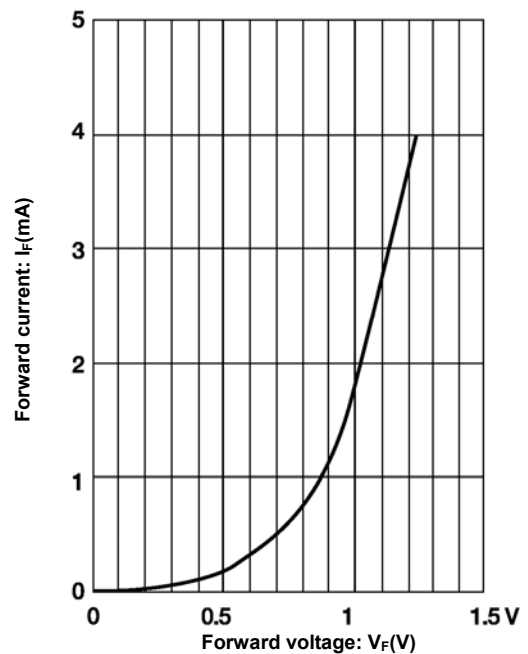

Figure 2. Typical high current forward conduction curve  $t_p=300\text{ms}$ , duty cycle=2%

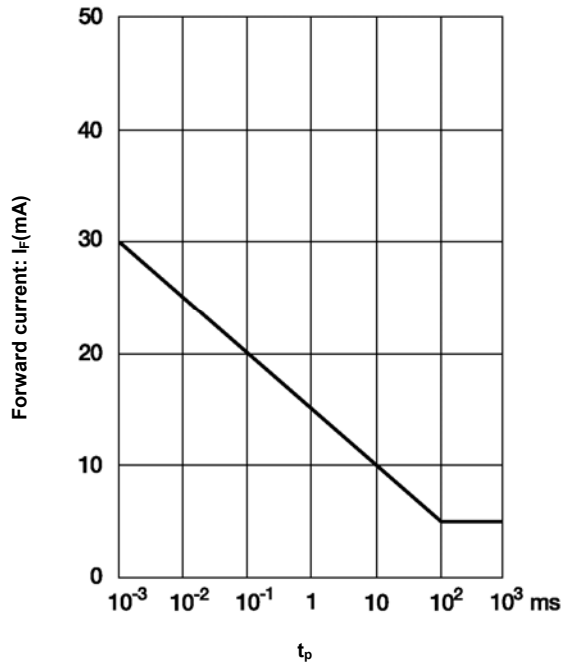

Figure 3. Typical non repetitive forward surge current vs. pulse width

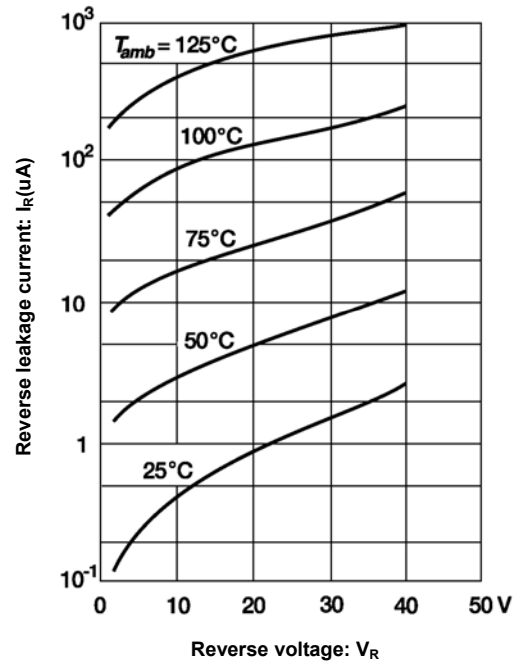

Figure 4. Typical variation of reverse current at various temperatures

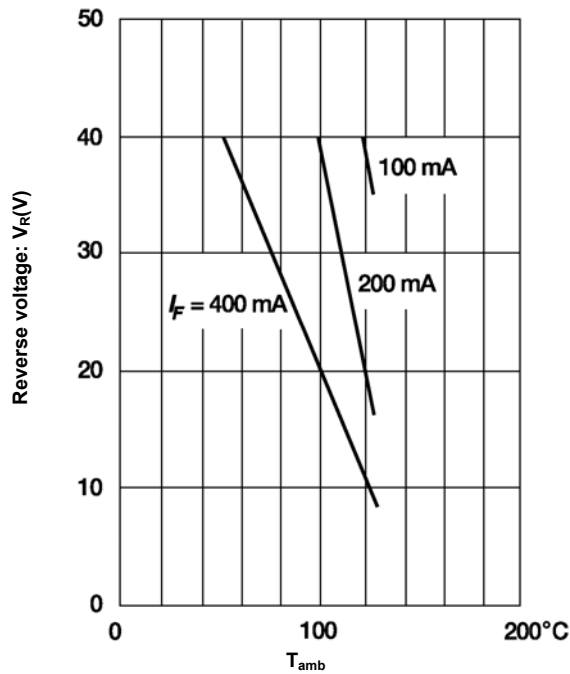

Figure 5. Blocking voltage duration vs. temperature at various average forward current

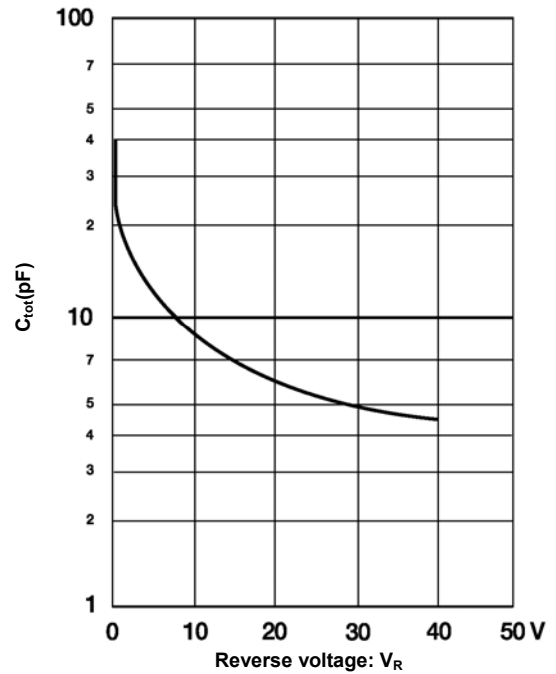
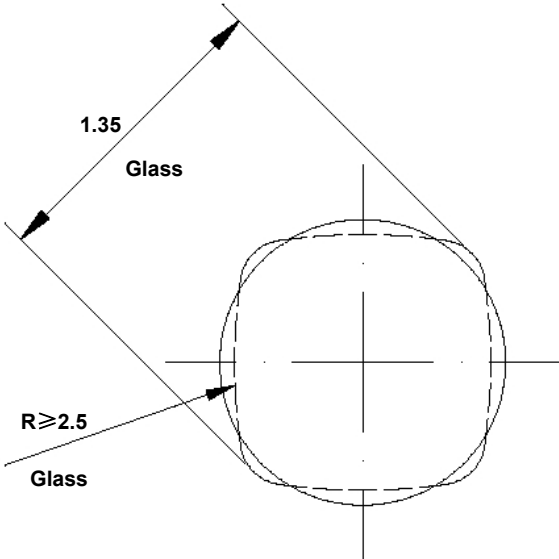
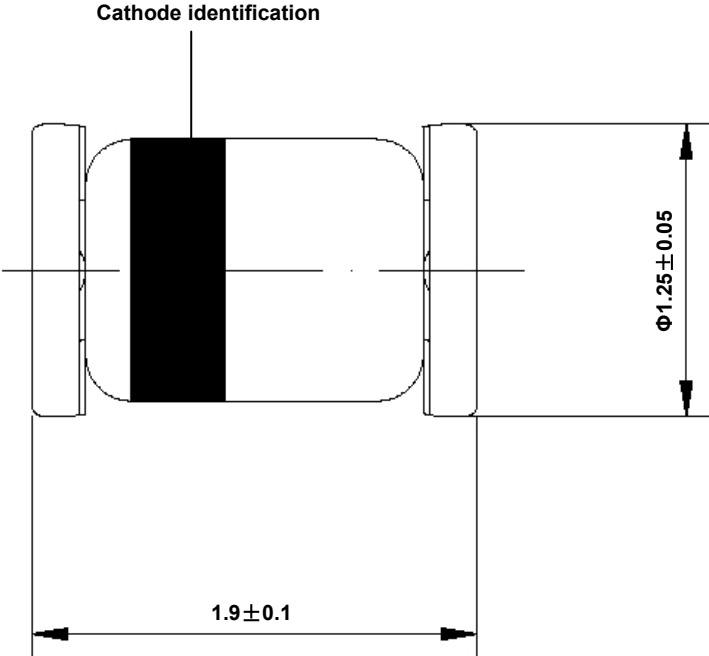

Figure 6. Typical capacitance vs. reverse voltage

Dimensions in mm



Glass Case  
Micro Melf