



DISCRIPTION

FEATURES

Higher Frequency
 High Saturation Material
 Low EMI Radiation
 Pick and PLace
 Low DC Resistance

OPTIONS

Tape & Reel is Standard (Qty:2000 Pcs)
 Bulk Packing Available for smaller quantites
 Tolerance: J=5% and K=10% is Standard,
 Tighter Tolerances Available

APPLICATIONS

Electronic Appliances
 DC-DC Conversion (Paraller Mode)
 Isolation/Coupling (Transformer)
 Input Filter (Serial Mode)
 EMI / RFI Suppression

PHYSICAL CHARACTERISTICS

- Testing: (Equivalent acceptable)
 Inductance:Reduced by 10% to 20% IDC
- RDC:QuadTech 1880 Milliohmmeter
- IDC Max:Lowers inductance by 10% - 20%
- Temperature range: -55°C to +125°C

ELECTRICAL SPECIFICATIONS

Properties	Test conditions		Value	Unit	Tol.
Inductance		L	270	μ H	see Site 2
Q factor		Q	---		min.
DC-resistance		DCR typ.	---	Ω	typ.
DC-resistance		DCR max.	0,46	Ω	max.
Self-Res. Freq.		SRF	---	KHz	min.
Test-Freq.			---	KHz	
Rated Current		IDC	0,75	mA	max.
Saturation Current		I SAT	---	A	max.

1. This electronic component is meant to be used in general electronic equipment. Before the incorporation of this component into any equipment with higher and more reliable requirements such as aviation, aerospace, submarine, nuclear control, transportation, transportation signal, disaster prevention, medical, public information network, etc. or if there is a possibility of injuries or damages to the human body, Edcon –Components must be informed before the stage of design-in. Evaluation checks for safety have to be performed on each electronic components used in electrical circuits that require high safety and reliability functions.

SMT WIRE WOUND DUAL CHIP INDUCTORS

Part No.: **S40002-271**

Customer:

DRW:	Chang	CHKD	Young	MATL:	Chu Chi	DATE	26.06.2009
APPD:	Pong			FINISH	Vienna	Sheet	1 from 2



TECHNICAL INFORMATIONS

Dimensions (mm)

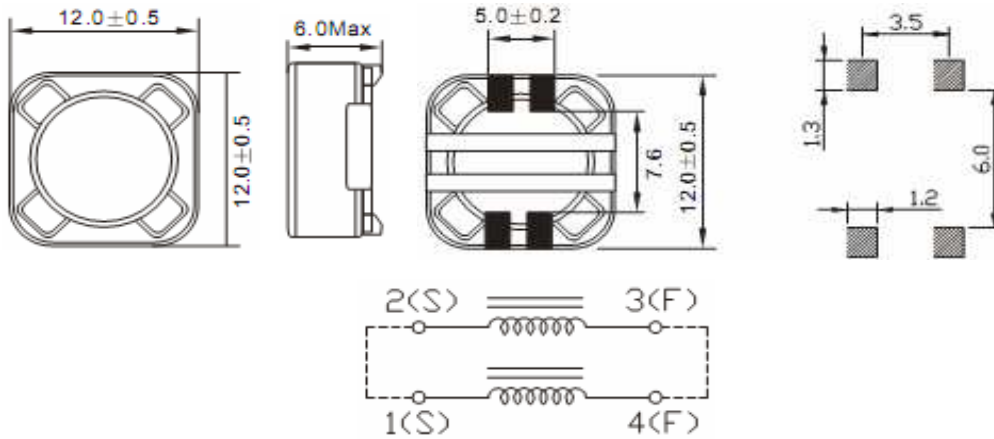

Ordering Information

Serie and Range	Tolerance	ROHS	Packing
S40002-271	M	R	TR
	J = 5%	R = ROHS	BU = Bulk Ware
	K = 10%	N = non ROHS	TR = Tape Reel
	M = 20%		
	N = 30%		

**Soldering Profile for Lead Free Soldering
255-260°C**

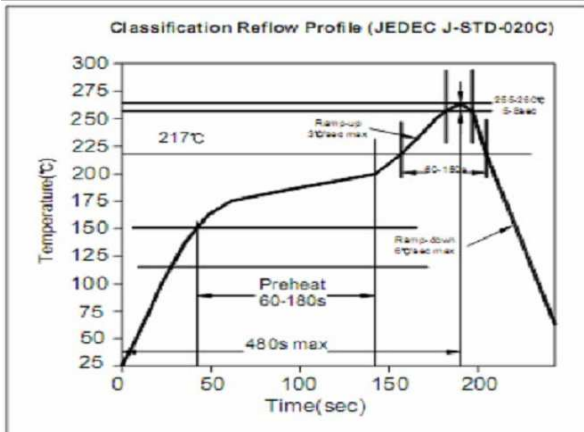

**Soldering Profile for Lead Free Soldering
235-240°C**

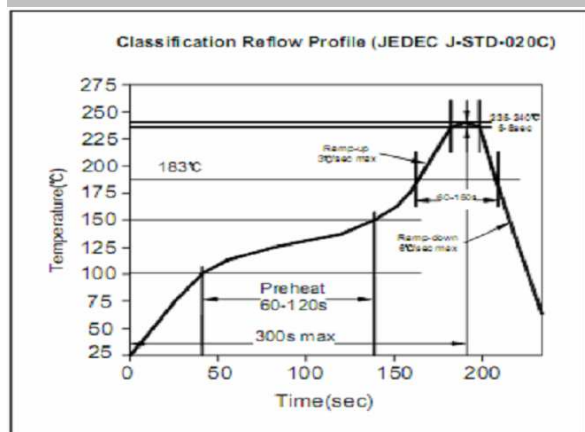

1. This electronic component is meant to be used in general electronic equipment. Before the incorporation of this component into any equipment with higher and more reliable requirements such as aviation, aerospace, submarine, nuclear control, transportation, transportation signal, disaster prevention, medical, public information network, etc. or if there is a possibility of injuries or damages to the human body, Edcon -Components must be informed before the stage of design-in. Evaluation checks for safety have to be performed on each electronic components used in electrical circuits that require high safety and reliability functions.

**SMT WIRE WOUND DUAL
CHIP INDUCTORS**

Part No.: **S40002-271**

Customer:

DRW:	Chang	CHKD	Young	MATL:	Chu Chi	DATE	26.06.2009
APPD:	Pong			FINISH	Vienna	Sheet	2 from 2