



## DISCRIPTION

### FEATURES

Higher Frequency  
 High Saturation Material  
 Low EMI Radiation  
 Pick and Place  
 Low DC Resistance

### OPTIONS

Tape & Reel is Standard  
 Tolerance: M=20% is Standard,  
 Tighter Tolerances Available

### APPLICATIONS

Electronic Appliances  
 Isolation / Coupling  
 EMI/RFI Suppression

## PHYSICAL CHARACTERISTICS

- Insulation Resistance: 100Vdc 1KM min
- Turns Ratio: 1,1 0%
- RDC: QuadTech 1880 Milliohmmer
- Soldering temperature:260°C for 1 seconds
- Operating temperature:-40°C ~ +125°C
- Storage Temperature: -55°C ~ +125°C
- Different package available per special request
- Max of 35% saturation on DC bias applied

## ELECTRICAL SPECIFICATIONS

Properties	Test conditions		Value	Unit	Tol.
OCL		nominal	49,71	µH	see Site 2
Q factor		Q	---		min.
DC-resistance		DCR typ.	---	Ω	typ.
DC-resistance		DCR max.	0,147	Ω	max.
Self-Res. Freq.		SRF	---	MHz	min.
Test-Freq.			100	KHz	
Rated Current		IDC	1,56	A	max.
Saturation Current		I SAT	---	A	max.

1. This electronic component is meant to be used in general electronic equipment. Before the incorporation of this component into any equipment with higher and more reliable requirements such as aviation, aerospace, submarine, nuclear control, transportation, transportation signal, disaster prevention, medical, public information network, etc. or if there is a possibility of injuries or damages to the human body, Edcon –Components must be informed before the stage of design-in. Evaluation checks for safety have to be performed on each electronic components used in electrical circuits that require high safety and reliability functions.

### SMT TOROIDAL COILS AND COMMON MODE TOROIDAL CHORES TRANSFORMER

Part No.: **S39036-500**

Customer:

DRW:	Chang	CHKD	Young	MATL:	Chu Chi	DATE	24.06.2009
APPD:	Pong			FINISH	Vienna	Sheet	1 from 2



## TECHNICAL INFORMATIONS

### Dimensions ( mm )

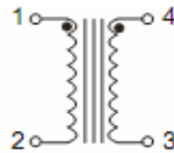
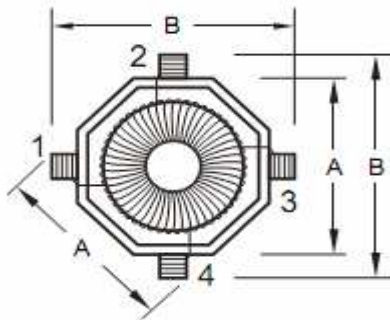

<b>A</b>	11,43
<b>B</b>	13,97
<b>C</b>	4,83
<b>D</b>	8,84
<b>E</b>	12,50
<b>F</b>	12,50
<b>G</b>	4,06

### Ordering Information

<b>Serie and Range</b>
<b>S39036-500</b>

<b>Tolerance</b>	<b>ROHS</b>	<b>Packing</b>
<b>M</b>	<b>R</b>	<b>TR</b>
<b>M = 20%</b>	<b>R = ROHS</b>	<b>BU = Bulk Ware</b>
	<b>N = non ROHS</b>	<b>TR = Tape Reel</b>

#### Soldering Profile for Lead Free Soldering 255-260°C



#### Soldering Profile for Lead Free Soldering 235-240°C



1. This electronic component is meant to be used in general electronic equipment. Before the incorporation of this component into any equipment with higher and more reliable requirements such as aviation, aerospace, submarine, nuclear control, transportation, transportation signal, disaster prevention, medical, public information network, etc. or if there is a possibility of injuries or damages to the human body, Edcon –Components must be informed before the stage of design-in. Evaluation checks for safety have to be performed on each electronic components used in electrical circuits that require high safety and reliability functions.

### SMT TOROIDAL COILS AND COMMON MODE TOROIDAL CHORES TRANSFORMER

Part No.: **S39036-500**

Customer:

DRW:	Chang	CHKD	Young	MATL:	Chu Chi	DATE	24.06.2009
APPD:	Pong			FINISH	Vienna	Sheet	2 from 2