

DISCRIPTION

FEATURES

Magnetic Shielded Surface Mount Inductor with High Current Rating

Low Resistance to Keep Power Loss Minimum.

OPTIONS

Tape & Reel is Standard (Qty:600 Pcs)
Bulk Packing Available for smaller quantities
Tolerance: Y=15% ; M=20% is Standard,
Tighter Tolerances Available

APPLICATIONS

Power Line DC-DC Converter
Hard disk, Notebook
Computers and other
Electronic Equipment

PHYSICAL CHARACTERISTICS

Materials :

- Core : Ferrite DR Core & RI Core
- Wire : Enamelled Copper Wire
- Base : LCP E4008
- Terminal : Tinned Copper Plate
- Adhesive: Epoxy Resin

General Specification :

- Storage Temperature : -40°C ~ +125°C
- Operation Temperature : -40°C ~ +105°C
- Rated Current: Base on Temperature & L/L0A=10% max
- Resistance to solder heat : 260°C , 10 sec.

ELECTRICAL SPECIFICATIONS

Properties	Test conditions		Value	Unit	Tol.
Inductance		L	100	μH	see Site 2
Q factor		Q	40		min.
DC-resistance		DCR typ.	---	mΩ	typ.
DC-resistance		DCR max.	0,42	mΩ	max.
Self-Res. Freq.		SRF	7,5	MHz	min.
Test-Freq.		L / Q	1 / 0,796	KHz / MHz	
Rated Current		IDC	0,7	A	max.
Saturation Current		I SAT	---	A	max.

1. This electronic component is meant to be used in general electronic equipment. Before the incorporation of this component into any equipment with higher and more reliable requirements such as aviation, aerospace, submarine, nuclear control, transportation, transportation signal, disaster prevention, medical, public information network, etc. or if there is a possibility of injuries or damages to the human body, Edcon -Components must be informed before the stage of design-in. Evaluation checks for safety have to be performed on each electronic components used in electrical circuits that require high safety and reliability functions.

SHIELDED SMD POWER INDUCTORS

Part No.: **S37001-101**

Customer:

DRW:	Chang	CHKD	Young	MATL:	Chu Chi	DATE	23.06.2009
APPD:	Pong			FINISH	Vienna	Sheet	1 from 2

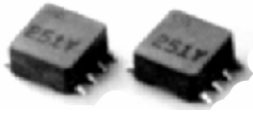

TECHNICAL INFORMATIONS

Dimensions (mm)

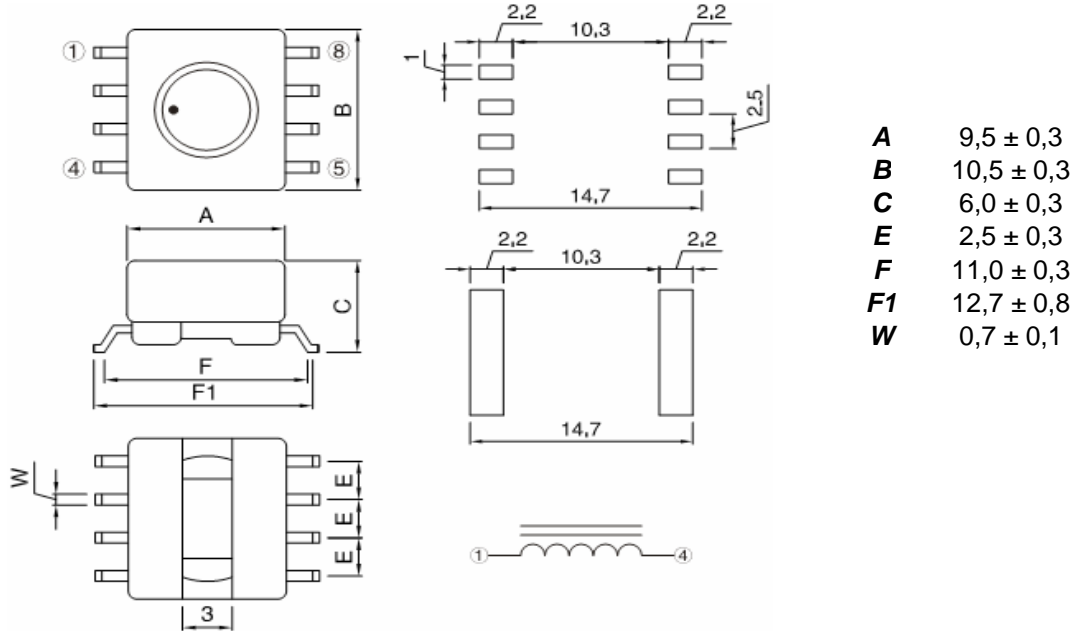

Ordering Information

Serie and Range	Tolerance	ROHS	Packing
S37001-101	M	R	TR
Y = 15%	R = ROHS	BU = Bulk Ware	
M = 20%	N = non ROHS	TR = Tape Reel	

**Soldering Profile for Lead Free Soldering
255-260°C**

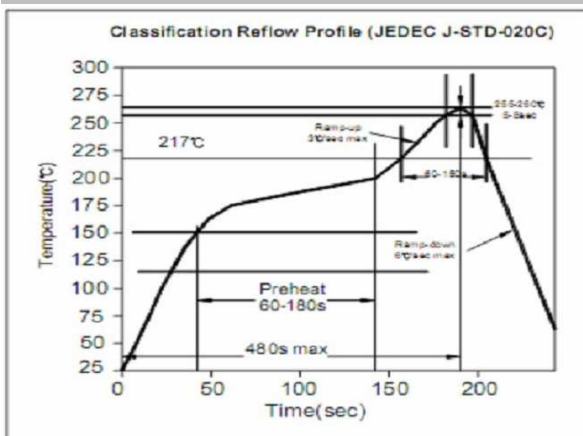

**Soldering Profile for Lead Free Soldering
235-240°C**

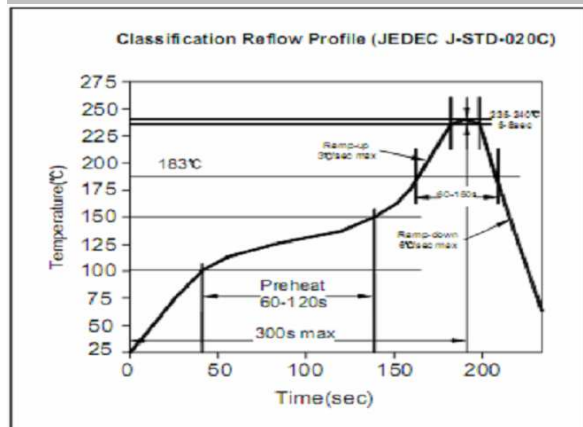

1. This electronic component is meant to be used in general electronic equipment. Before the incorporation of this component into any equipment with higher and more reliable requirements such as aviation, aerospace, submarine, nuclear control, transportation, transportation signal, disaster prevention, medical, public information network, etc. or if there is a possibility of injuries or damages to the human body, Edcon -Components must be informed before the stage of design-in. Evaluation checks for safety have to be performed on each electronic components used in electrical circuits that require high safety and reliability functions.

**SHIELDED SMD
POWER INDUCTORS**

Part No.: **S37001-101**

Customer:

DRW:	Chang	CHKD	Young	MATL:	Chu Chi	DATE	23.06.2009
APPD:	Pong			FINISH	Vienna	Sheet	2 from 2