



DISCRIPTION

FEATURES

Magnetically Shielded Structure
 Low DC Resistance
 Excellent Mechanical Strength
 High Reliability and Excellent Solderability
 Low and square Profile
 High heat resistance

OPTIONS

Tape & Reel is Standard (Qty : 2000 pcs)
 Bulk Packing Available for smaller quantities
 Tolerance: M=20% ; N=30% is Standard,
 Tighter Tolerances Available

APPLICATIONS

VCRs, Notebook, DC/DC Converters
 Video Digital Cameras
 Communication System
 Automotive System Power supplier
 LCD PDP Televisions
 Hard Disk Drives, Topset, XDSL
 Computer Peripheral Equipment

PHYSICAL CHARACTERISTICS

- Inductor Testing : HP4284A (Equivalent acceptable)
 DCR : QuadTech 1880 mΩ Q-HP4342A - SRF- HP4191A
 IDCMax current is decreased 10% against its initial value
- Operating temperature : -40°C ~ +105°C
- Storage temperature : -40°C ~ +105°C
- Solder methods : Vapor Phase, Infrared Reflow
- Resistance to soldering heat : 260°C for 10 seconds

ELECTRICAL SPECIFICATIONS

Properties	Test conditions		Value	Unit	Tol.
Inductance		L	3,3	μH	see Site 2
Q factor		Q	---		min.
DC-resistance		DCR typ.	---	Ω	typ.
DC-resistance		DCR max.	0,123	Ω	max.
Self-Res. Freq.		SRF	---	KHz	min.
Test-Freq.			100	KHz	
Rated Current		IDC	0,60	A	max.
Saturation Current		I SAT	---	A	max.

1. This electronic component is meant to be used in general electronic equipment. Before the incorporation of this component into any equipment with higher and more reliable requirements such as aviation, aerospace, submarine, nuclear control, transportation, transportation signal, disaster prevention, medical, public information network, etc. or if there is a possibility of injuries or damages to the human body, Edcon –Components must be informed before the stage of design-in. Evaluation checks for safety have to be performed on each electronic components used in electrical circuits that require high safety and reliability functions.

MAGNETIC SHIELDED SMT POWER INDUCTOR

Part No.: **S26001-3R3**

Customer:

DRW:	Chang	CHKD	Young	MATL:	Chu Chi	DATE	18.06.2009
APPD:	Pong			FINISH	Vienna	Sheet	1 from 2

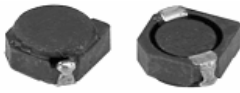

TECHNICAL INFORMATIONS

Dimensions (mm)

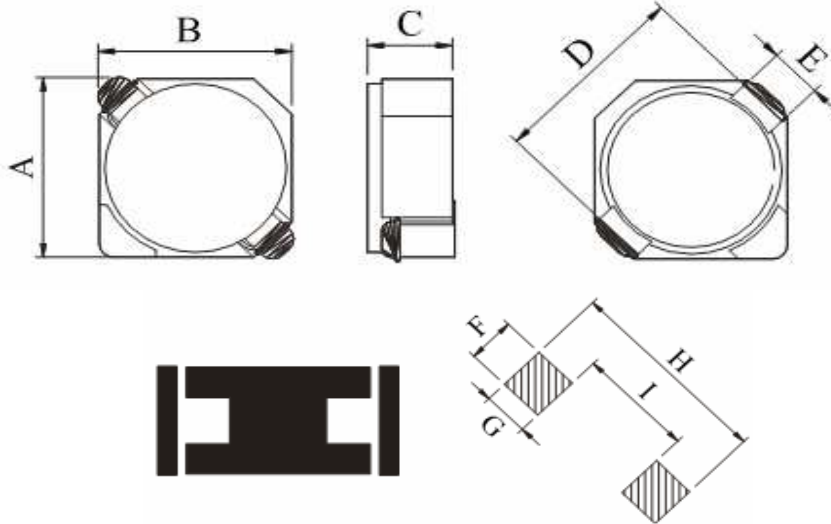

A	3,2 max
B	3,2 max
C	1,2 max
D	3,3
E	1,0
F	1,3
G	1,3
H	4,3
I	1,7

Ordering Information

Serie and Range	Tolerance	ROHS	Packing
S26001-3R3	M	R	TR
	K = 10%	R = ROHS	BU = Bulk Ware
	M = 20%	N = non ROHS	TR = Tape Reel
	N = 30%		

**Soldering Profile for Lead Free Soldering
235-240°C**



**Soldering Profile for Lead Free Soldering
255-260°C**



1. This electronic component is meant to be used in general electronic equipment. Before the incorporation of this component into any equipment with higher and more reliable requirements such as aviation, aerospace, submarine, nuclear control, transportation, transportation signal, disaster prevention, medical, public information network, etc. or if there is a possibility of injuries or damages to the human body, Edcon –Components must be informed before the stage of design-in. Evaluation checks for safety have to be performed on each electronic components used in electrical circuits that require high safety and reliability functions.

**MAGNETIC
SHIELDED SMT
POWER INDUCTOR**

Part No.: **S26001-3R3**

Customer:

DRW:	Chang	CHKD	Young	MATL:	Chu Chi	DATE	18.06.2009
APPD:	Pong			FINISH	Vienna	Sheet	2 from 2