



DISCRIPTION

FEATURES

Ceramic housing
 High Frequency Design
 Excellent Q Values
 Excellent SRF
 Excellent Thermal Stability
 Low profile
 Small Foot Print

OPTIONS

Tape & Reel is Standard (Qty : 2000 pcs)
 Bulk Packing Available for smaller quantities
 Tolerance: K=10% ; M=20% is Standard,
 Tighter Tolerances Available

APPLICATIONS

Modems
 Mobile Radios
 Cordless Telephones
 Wireless Communications Equipment
 Networking System, xDSL Filter
 Computer Products and Peripherals

PHYSICAL CHARACTERISTICS

- Inductance (L) measured @ noted frequencies with 0 DC bias HP 4284A
- Operating Temperature : -55°C ~ +85°C
- Inductance Drops By 10% at Max rated in uH
- Marking per EIA Standard colour code in uH

ELECTRICAL SPECIFICATIONS

Properties	Test conditions		Value	Unit	Tol.
Inductance		L	68	µH	see Site 2
Q factor		Q	---		min.
DC-resistance		DCR typ.	---	Ω	typ.
DC-resistance		DCR max.	1,10	Ω	max.
Self-Res. Freq.		SRF	---	KHz	min.
Test-Freq.			100	KHz	
Rated Current		IDC	0,40	A	max.
Saturation Current		I SAT	---	A	max.

1. This electronic component is meant to be used in general electronic equipment. Before the incorporation of this component into any equipment with higher and more reliable requirements such as aviation, aerospace, submarine, nuclear control, transportation, transportation signal, disaster prevention, medical, public information network, etc. or if there is a possibility of injuries or damages to the human body, Edcon –Components must be informed before the stage of design-in. Evaluation checks for safety have to be performed on each electronic components used in electrical circuits that require high safety and reliability functions.

LOW PROFILE SMT POWER INDUCTORS

Part No.: **S24003-680**

Customer:

DRW:	Chang	CHKD	Young	MATL:	Chu Chi	DATE	18.06.2009
APPD:	Pong			FINISH	Vienna	Sheet	1 from 2



TECHNICAL INFORMATIONS

Dimensions (mm)

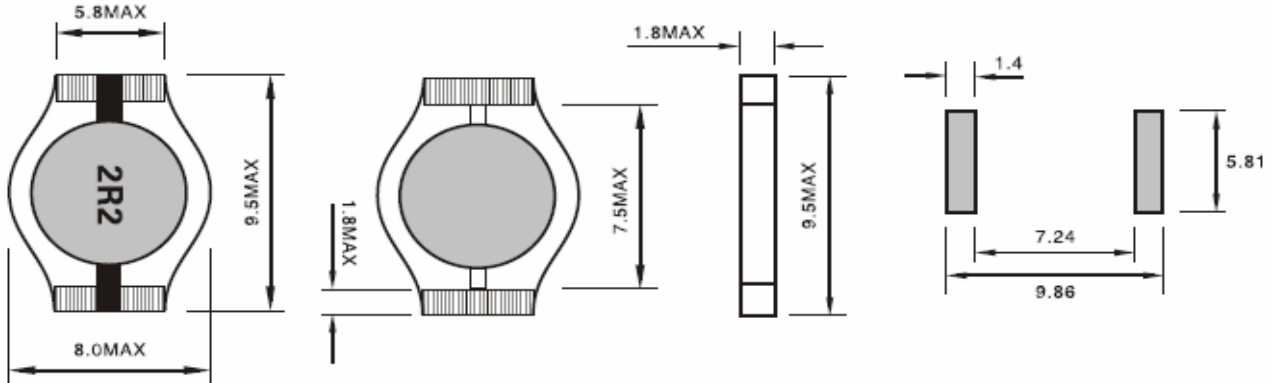

Ordering Information

Serie and Range	Tolerance	ROHS	Packing
S24003-680	M	R	TR
	K = 10%	R = ROHS	BU = Bulk Ware
	M = 20%	N = non ROHS	TR = Tape Reel

**Soldering Profile for Lead Free Soldering
235-240°C**

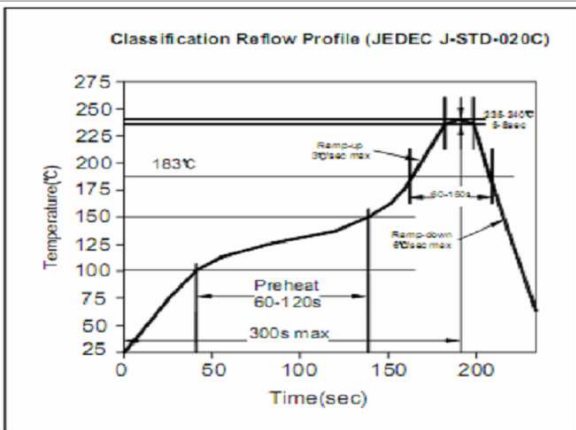

**Soldering Profile for Lead Free Soldering
255-260°C**



1. This electronic component is meant to be used in general electronic equipment. Before the incorporation of this component into any equipment with higher and more reliable requirements such as aviation, aerospace, submarine, nuclear control, transportation, transportation signal, disaster prevention, medical, public information network, etc. or if there is a possibility of injuries or damages to the human body, Edcon-Components must be informed before the stage of design-in. Evaluation checks for safety have to be performed on each electronic components used in electrical circuits that require high safety and reliability functions.

**LOW PROFILE SMT
POWER INDUCTORS**

Part No.: **S24003-680**

Customer:

DRW:	Chang	CHKD	Young	MATL:	Chu Chi	DATE	18.06.2009
APPD:	Pong			FINISH	Vienna	Sheet	2 from 2