



## DISCRIPTION

### FEATURES

Ceramic housing  
 High Frequency Design  
 Excellent Q Values  
 Excellent SRF  
 Excellent Thermal Stability  
 Low profile  
 Small Foot Print

### OPTIONS

Tape & Reel is Standard ( Qty : 2000 pcs )  
 Bulk Packing Available for smaller quantities  
 Tolerance: K=10% ; M=20% is Standard,  
 Tighter Tolerances Available

### APPLICATIONS

Modems  
 Mobile Radios  
 Cordless Telephones  
 Wireless Communications Equipment  
 Networking System, xDSL Filter  
 Computer Products and Peripherals

### PHYSICAL CHARACTERISTICS

- Inductance ( L ) measured @ noted frequencies with 0 DC bias HP 4284A
- Operating Temperature : -55°C ~ +85°C
- Inductance Drops By 10% at Max rated in uH
- Marking per EIA Standard colour code in uH

### ELECTRICAL SPECIFICATIONS

Properties	Test conditions		Value	Unit	Tol.
Inductance		L	18	µH	see Site 2
Q factor		Q	40		min.
DC-resistance		DCR typ.	---	Ω	typ.
DC-resistance		DCR max.	0,450	Ω	max.
Self-Res. Freq.		SRF	---	KHz	min.
Test-Freq.			100	KHz	
Rated Current		IDC	0,51	A	max.
Saturation Current		I SAT	---	A	max.

1. This electronic component is meant to be used in general electronic equipment. Before the incorporation of this component into any equipment with higher and more reliable requirements such as aviation, aerospace, submarine, nuclear control, transportation, transportation signal, disaster prevention, medical, public information network, etc. or if there is a possibility of injuries or damages to the human body, Edcon –Components must be informed before the stage of design-in. Evaluation checks for safety have to be performed on each electronic components used in electrical circuits that require high safety and reliability functions.

### LOW PROFILE SMT POWER INDUCTORS

Part No.: **S24001-180**

Customer:

DRW:	Chang	CHKD	Young	MATL:	Chu Chi	DATE	18.06.2009
APPD:	Pong			FINISH	Vienna	Sheet	1 from 2



**TECHNICAL INFORMATIONS**

**Dimensions ( mm )**

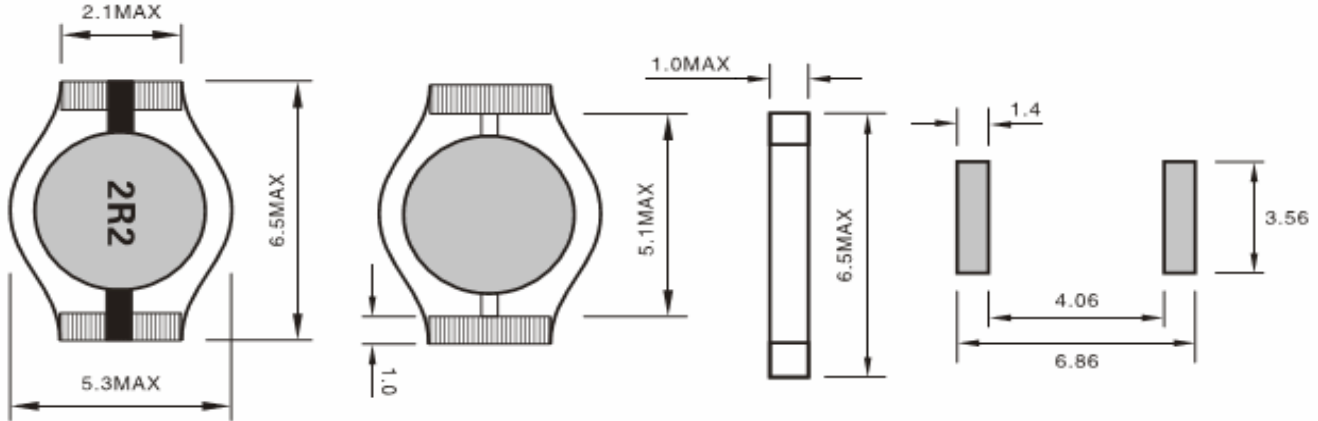

**Ordering Information**

<b>Serie and Range</b>	<b>Tolerance</b>	<b>ROHS</b>	<b>Packing</b>
<b>S24001-180</b>	<b>M</b>	<b>R</b>	<b>TR</b>
	<b>K = 10%</b>	<b>R = ROHS</b>	<b>BU = Bulk Ware</b>
	<b>M = 20%</b>	<b>N = non ROHS</b>	<b>TR = Tape Reel</b>

**Soldering Profile for Lead Free Soldering  
235-240°C**

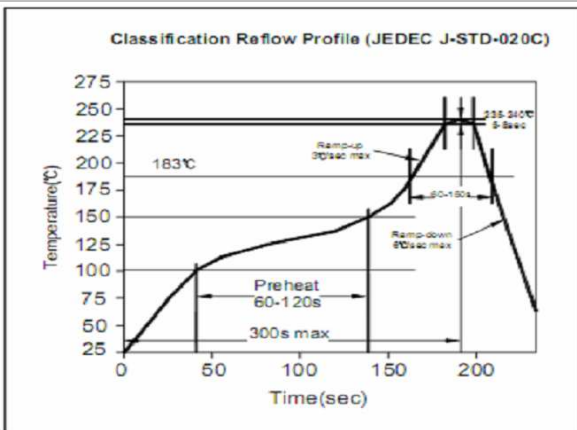

**Soldering Profile for Lead Free Soldering  
255-260°C**



1. This electronic component is meant to be used in general electronic equipment. Before the incorporation of this component into any equipment with higher and more reliable requirements such as aviation, aerospace, submarine, nuclear control, transportation, transportation signal, disaster prevention, medical, public information network, etc. or if there is a possibility of injuries or damages to the human body, Edcon-Components must be informed before the stage of design-in. Evaluation checks for safety have to be performed on each electronic components used in electrical circuits that require high safety and reliability functions.

**LOW PROFILE SMT  
POWER INDUCTORS**

Part No.: **S24001-180**

Customer:

DRW:	Chang	CHKD	Young	MATL:	Chu Chi	DATE	18.06.2009
APPD:	Pong			FINISH	Vienna	Sheet	2 from 2