



## DISCRIPTION

### FEATURES

Very Small Foot Print  
Flat-top for Pick & Place  
Increased Size Selection Guide

### OPTIONS

Tape & Reel is Standard  
Bulk Packing Available for smaller quantities  
Tolerance: M=20% is Standard

### APPLICATIONS

Ideal for Palm-Top and Laptop  
DC to Dc converter  
PDA's flash memory  
Step-up, step-down Converters

## PHYSICAL CHARACTERISTICS

- measuring Frequency ( L ) : 1 KHz, 0.1 Vrms, HP4284A
- Operating Temperature : -40°C ~ +85°C
- Storage Temperature : -40°C ~ +105°C
- Soldering Methods : Vapor Phase, Infrared Reflow
- Resistance to soldering heat : 260°C for 10 seconds
- Solvent resistance : Conforms to MIL-STD-202E

## ELECTRICAL SPECIFICATIONS

Properties	Test conditions		Value	Unit	Tol.
Inductance		<b>L</b>	3,3	$\mu$ H	see Site 2
Q factor		<b>Q</b>	---		min.
DC-resistance		<b>DCR typ.</b>	---	$\Omega$	typ.
DC-resistance		<b>DCR max.</b>	0,016	$\Omega$	max.
Self-Res. Freq.		<b>SRF</b>	---	MHz	min.
Test-Freq.			0,001	MHz	
Rated Current		<b>IDC</b>	14,00	A	max.
Saturation Current		<b>Isat</b>	---	A	typ.

1. This electronic component is meant to be used in general electronic equipment. Before the incorporation of this component into any equipment with higher and more reliable requirements such as aviation, aerospace, submarine, nuclear control, transportation, transportation signal, disaster prevention, medical, public information network, etc. or if there is a possibility of injuries or damages to the human body, Edcon -Components must be informed before the stage of design-in. Evaluation checks for safety have to be performed on each electronic components used in electrical circuits that require high safety and reliability functions.

### SMT POWER INDUCTOR

Part No.: **S21006-3R3**

Customer:

DRW:	Chang	CHKD	Young	MATL:	Chu Chi	DATE	16.06.2009
APPD:	Pong			FINISH	Vienna	Sheet	1 from 2



## TECHNICAL INFORMATIONS

### Dimensions ( mm )

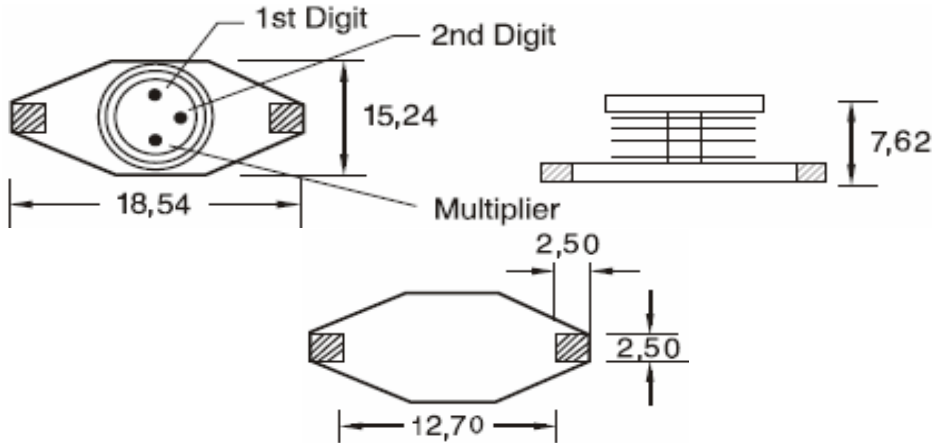

### Ordering Information

Serie and Range	Tolerance	ROHS	Packing
S21006-3R3	M	R	TR
	M = 20%	R = ROHS N = non ROHS	BU = Bulk Ware TR = Tape Reel

### Soldering Profile for Lead Free Soldering 235-240°C



### Soldering Profile for Lead Free Soldering 255-260°C

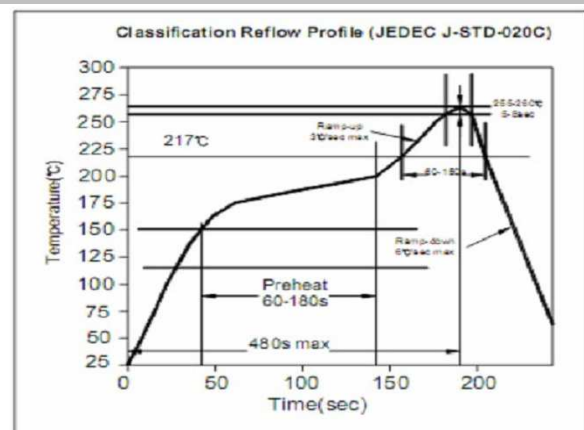

1. This electronic component is meant to be used in general electronic equipment. Before the incorporation of this component into any equipment with higher and more reliable requirements such as aviation, aerospace, submarine, nuclear control, transportation, transportation signal, disaster prevention, medical, public information network, etc. or if there is a possibility of injuries or damages to the human body, Edcon -Components must be informed before the stage of design-in. Evaluation checks for safety have to be performed on each electronic components used in electrical circuits that require high safety and reliability functions.

### SMT POWER INDUCTOR

Part No.: **S21006-3R3**

Customer:

DRW:	Chang	CHKD	Young	MATL:	Chu Chi	DATE	16.06.2009
APPD:	Pong			FINISH	Vienna	Sheet	2 from 2