



DISCRIPTION

FEATURES

Very Small Foot Print
Flat-top for Pick & Place
Increased Size Selection Guide

OPTIONS

Tape & Reel is Standard
Bulk Packing Available for smaller quantities
Tolerance: M=20% is Standard

APPLICATIONS

Ideal for Palm-Top and Laptop
DC to Dc converter
PDA's flash memory
Step-up, step-down Converters

PHYSICAL CHARACTERISTICS

- measuring Frequency (L) : 1 KHz, 0.1 Vrms, HP4284A
- Operating Temperature : -40°C ~ +85°C
- Storage Temperature : -40°C ~ +105°C
- Soldering Methods : Vapor Phase, Infrared Reflow
- Resistance to soldering heat : 260°C for 10 seconds
- Solvent resistance : Conforms to MIL-STD-202E

ELECTRICAL SPECIFICATIONS

Properties	Test conditions		Value	Unit	Tol.
Inductance		L	15	μ H	see Site 2
Q factor		Q	---		min.
DC-resistance		DCR typ.	---	Ω	typ.
DC-resistance		DCR max.	0,12	Ω	max.
Self-Res. Freq.		SRF	---	MHz	min.
Test-Freq.			0,001	MHz	
Rated Current		IDC	2,00	A	max.
Saturation Current		Isat	---	A	typ.

1. This electronic component is meant to be used in general electronic equipment. Before the incorporation of this component into any equipment with higher and more reliable requirements such as aviation, aerospace, submarine, nuclear control, transportation, transportation signal, disaster prevention, medical, public information network, etc. or if there is a possibility of injuries or damages to the human body, Edcon -Components must be informed before the stage of design-in. Evaluation checks for safety have to be performed on each electronic components used in electrical circuits that require high safety and reliability functions.

SMT POWER INDUCTOR

Part No.: **S21002-150**

Customer:

DRW:	Chang	CHKD	Young	MATL:	Chu Chi	DATE	16.06.2009
APPD:	Pong			FINISH	Vienna	Sheet	1 from 2



TECHNICAL INFORMATIONS

Dimensions (mm)

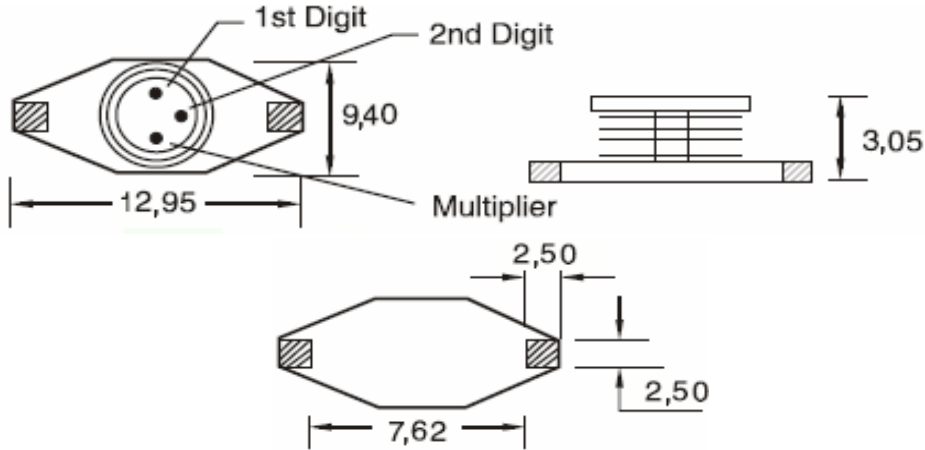

Ordering Information

Serie and Range	Tolerance	ROHS	Packing
S21002-150	M	R	TR
	M = 20%	R = ROHS N = non ROHS	BU = Bulk Ware TR = Tape Reel

**Soldering Profile for Lead Free Soldering
235-240°C**

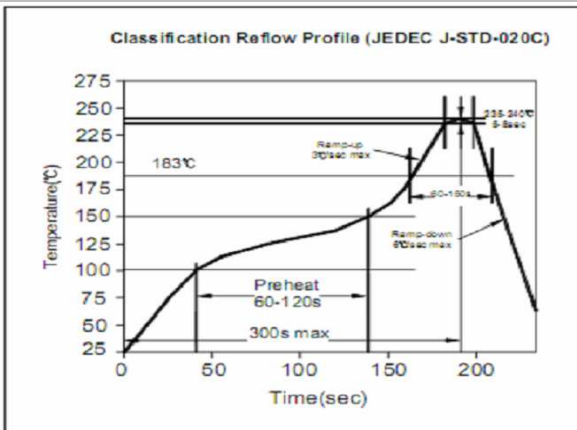

**Soldering Profile for Lead Free Soldering
255-260°C**

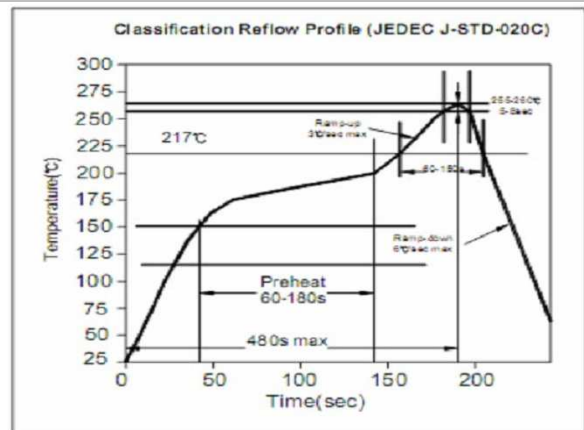

1. This electronic component is meant to be used in general electronic equipment. Before the incorporation of this component into any equipment with higher and more reliable requirements such as aviation, aerospace, submarine, nuclear control, transportation, transportation signal, disaster prevention, medical, public information network, etc. or if there is a possibility of injuries or damages to the human body, Edcon-Components must be informed before the stage of design-in. Evaluation checks for safety have to be performed on each electronic components used in electrical circuits that require high safety and reliability functions.

**SMT POWER
INDUCTOR**

Part No.: **S21002-150**

Customer:

DRW:	Chang	CHKD	Young	MATL:	Chu Chi	DATE	16.06.2009
APPD:	Pong			FINISH	Vienna	Sheet	2 from 2