



## DISCRIPTION

### FEATURES

Ferrite Core  
 High Frequency Desgin  
 Lower DCR permits High Idc  
 Available in E 12 serie  
 Excellent Q SRF Values  
 Excellent Thermal Stability  
 Lead Free versions

### OPTIONS

Tape & Reel is Standard ( Qty: 2000 Pcs )  
 Bulk Packing Available for smaller quantites  
 Tolerance: K = 10% and M=20% is Standard,  
 tighter Tolerance available ( MOQ on request )

### APPLICATIONS

Modems PDP, LCD TVs convertor  
 Mobile Radios DC/DC convertor  
 Cordless Telephones Car radios  
 Global Positioning Systems  
 Wireless Communications Equipment  
 Network Systems  
 Computer Peripheral Equipment

## PHYSICAL CHARACTERISTICS

- Testing : ( Equivalents acceptable ) Inductance : HP4291A  
 RDC : QuadTech 1880 mΩ Q : HP4342A SRF : HP4191A
- Rated Current L value drop 10% typ at IDC against its initial value
- Temperature rise 40°C Max Reference ambient temperature
- Solderability : 75% of the terminal electrode shall be covered
- Soldering Methods : Wave, Reflow
- Operating Temperature : -25°C ~ +85°C
- Storage Temperature : -55°C ~ +125°C

## ELECTRICAL SPECIFICATIONS

Properties	Test conditions		Value	Unit	Tol.
Inductance		<b>L</b>	1,2	μH	see Site 2
Q factor		<b>Q</b>	35		min.
DC-resistance		<b>DCR typ.</b>	---	Ω	typ.
DC-resistance		<b>DCR max.</b>	0,09	Ω	max.
Self-Res. Freq.		<b>SRF</b>	100	Mhz	min.
Test-Freq.			1 / 1	KHz / Mhz	
Rated Current		<b>IDC</b>	290	mA	max.
Saturation Current		<b>Isat</b>	---	mA	typ.

1. This electronic component is meant to be used in general electronic equipment. Before the incorporation of this component into any equipment with higher and more reliable requirements such as aviation, aerospace, submarine, nuclear control, transportation, transportation signal, disaster prevention, medical, public information network, etc. or if there is a possibility of injuries or damages to the human body, Edcon -Components must be informed before the stage of design-in. Evaluation checks for safety have to be performed on each electronic components used in electrical circuits that require high safety and reliability functions.

### HIGH CURRENT SMT WIRE-WOUND CHIP INDUCTORS

Part No.: **S15001-1R2**

Customer:

DRW:	Chang	CHKD	Young	MATL:	Chu Chi	DATE	10.06.2009
APPD:	Pong			FINISH	Vienna	Sheet	1 from 2



## TECHNICAL INFORMATIONS

### Dimensions ( mm )

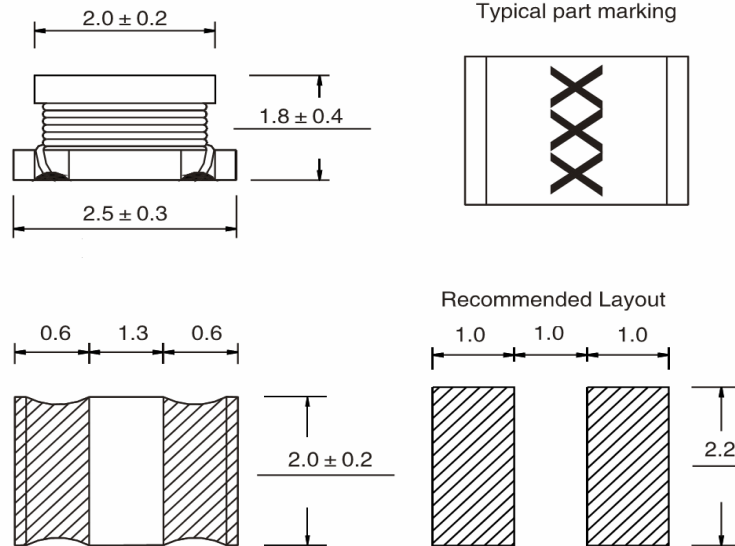

### Ordering Information

Serie and Range	Tolerance	ROHS	Packing
S15001-1R2	K	R	TR
	K = 10%	R = ROHS	BU = Bulk Ware
	M = 20%	N = non ROHS	TR = Tape Reel

### Soldering Profile for Lead Free Soldering 235-240°C

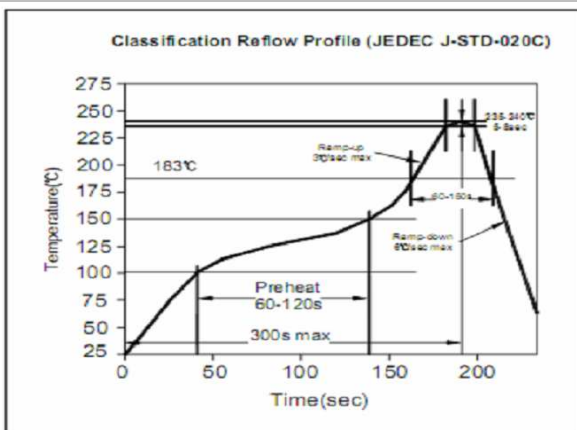

### Soldering Profile for Lead Free Soldering 255-260°C

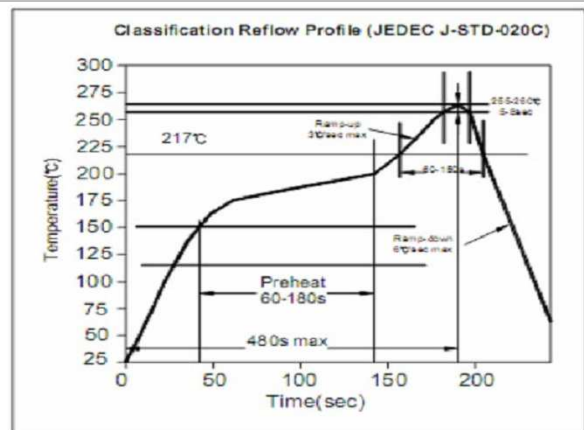

1. This electronic component is meant to be used in general electronic equipment. Before the incorporation of this component into any equipment with higher and more reliable requirements such as aviation, aerospace, submarine, nuclear control, transportation, transportation signal, disaster prevention, medical, public information network, etc. or if there is a possibility of injuries or damages to the human body, Edcon -Components must be informed before the stage of design-in. Evaluation checks for safety have to be performed on each electronic components used in electrical circuits that require high safety and reliability functions.

### HIGH CURRENT SMT WIRE-WOUND CHIP INDUCTORS

Part No.: **S15001-1R2**

Customer:

DRW:	Chang	CHKD	Young	MATL:	Chu Chi	DATE	10.06.2009
APPD:	Pong			FINISH	Vienna	Sheet	2 from 2