



# DATA SHEET

## THT BCD ROTARY Switch

### Serie: Q27003

**THT BCD ROTARY Switch**

Serie No.: **Q27003**

Customer:

DRW:	Jason	CHKD	Wilson	MATL:	Wilson	TOLERANCE	Mason	DATE	21.04.2017
APPD:	Schumi			FINISH	Jamy		Sheet No.	1 from 6	

# EDCON-COMPONENTS



## Specifications

### Material

Housing/Knob:	Thermoplastic
O-Ring:	Silicone Rubber
Terminal:	Precisious metal on phosphor bronze

### Mechanical:

Switching Positions	8, 10,16 positions
Operating force:	350gr-cm max.
Life:	10.000detens

### Electrical:

Max. Load Rating:	
Switching:	50mA, 24VDC
Non Switching:	100mA, 50VDC
Contact Resistance:	100mΩ max.
Insulation Resistance:	1000M Ω at 100VDC
Dielectric Strength:	250VAC for 1 minute

### Environmental:

Operating Temperature:	. -10°C to +70°C
Soldering Temperature:	max. 250 ± 5°C for 5 seconds

## Features

- Fully Sealed construction
- Low Profile , Low Cost
- Gold Plated contacts
- Molded-In terminals
- Snap-In mounting on PCB

**THT BCD ROTARY Switch**

Part No.: **Q27003**

Customer:

DRW:	Jason	CHKD	Wilson	MATL:	Wilson	TOLERANCE	Mason	DATE	21.04.2017
APPD:	Schumi			FINISH	Jamy		Sheet No.	2 from 6	

# EDCON-COMPONENTS



Switch Code

BCD Order Code = 08S					
Position	BCD 8 Position				
	Common c contacted				
	1	2	4	8	C
0					
1					
2					
3					
4					
5					
6					
7					

BCD Order Code = 16S					
Position	BCD 16 Position				
	Common c contacted				
	1	2	4	8	C
0					
1					
2					
3					
4					
5					
6					
7					
8					
9					
A					
B					
C					
D					
E					
F					

BCD Order Code = 10C					
Position	BCD Complement 10Pos.				
	Common c contacted				
	1	2	4	8	C
0					
1					
2					
3					
4					
5					
6					
7					
8					
9					

BCD Order Code = 10S					
Position	BCD 10 Position				
	Common c contacted				
	1	2	4	8	C
0					
1					
2					
3					
4					
5					
6					
7					
8					
9					

<b>THT BCD ROTARY Switch</b>	
Part No.:	<b>Q27003</b>
Customer:	

DRW:	Jason	CHKD	Wilson	MATL:	Wilson	TOLERANCE	Mason	DATE	21.04.2017
APPD:	Schumi			FINISH	Jamy		Sheet No.		2 from 6

# EDCON-COMPONENTS



Switch Code

Technical Dimensions (mm)

PCB Layout (mm)

Position	BCD Order Code = 16C				
	BCD Complement 16 Position				
	Common c contacted				
	1	2	4	8	C
0					
1					
2					
3					
4					
5					
6					
7					
8					
9					
A					
B					
C					
D					
E					
F					

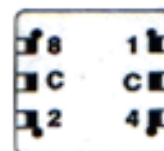
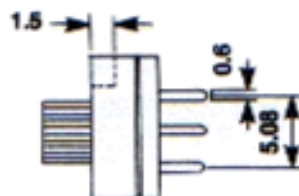
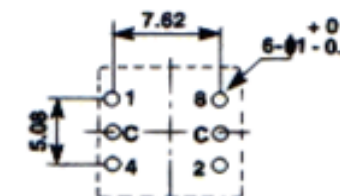
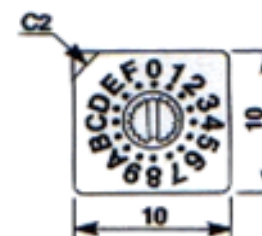
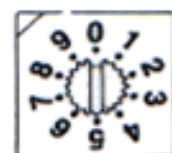
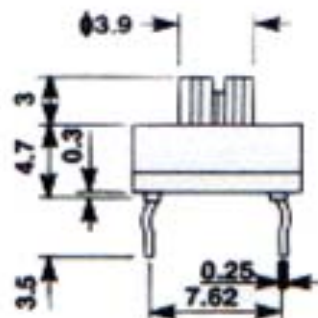

Terminal Order Code 3 = (3+3)

**THT BCD ROTARY Switch**

Part No.: **Q27003**

DRW:	Jason	CHKD	Wilson	MATL:	Wilson	TOLERANCE	Mason	DATE	21.04.2017
APPD:	Schumi			FINISH	Jamy		Sheet No.	4 from 6	Customer:

[www.edcon-components.com](http://www.edcon-components.com)

email: [info@edcon-components.com](mailto:info@edcon-components.com)

# EDCON-COMPONENTS



## Ordering Informations

Serie	BCD Order Code	Rotor Style	Terminal Style	ROHS	Packing Code					
<b>Q27003</b>	<b>10S</b>	<b>03</b>	<b>3</b>	<b>R</b>	<b>TU</b>					

<b>10S=</b> Type 10S	<b>03=</b> 3mm Long Type	<b>3=</b> (3+3) Legs	<b>R=</b> ROHS Conform	<b>TU=</b> Tube Packing
<b>08S=</b> Type 08S			<b>N=</b> NON ROHS Conform	<b>TY=</b> Tray Packing
<b>16S=</b> Type 16S				<b>BU=</b> Bulk Ware
<b>10C=</b> Type 10C				
<b>16C=</b> Type 16C				

**THT BCD ROTARY Switch**

Part No.: **Q27003**

DRW:	Jason	CHKD	Wilson	MATL:	Wilson	TOLERANCE	Mason	DATE	21.04.2017	Customer:
APPD:	Schumi			FINISH	Jamy		Sheet No.	5 from 6		



Soldering Profile Curve

Classification Reflow Profile (JEDEC J-STD-020C)

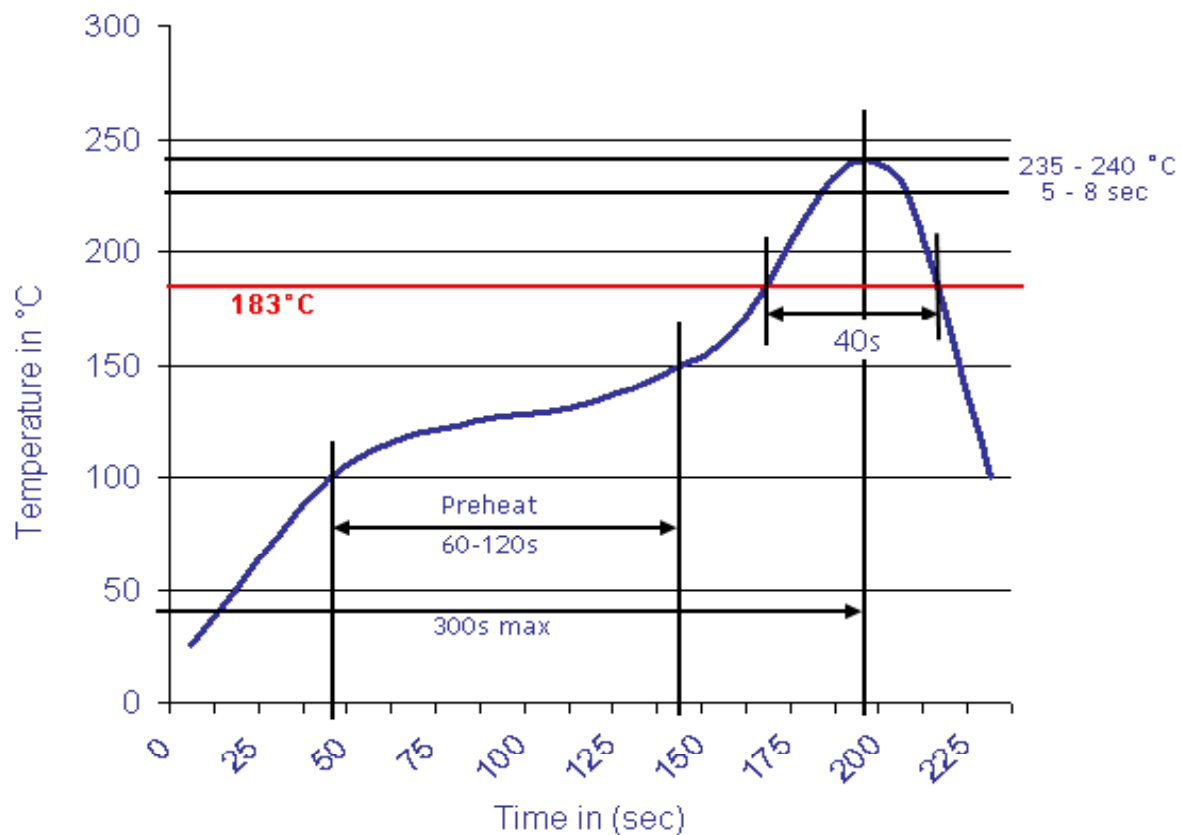

THT BCD ROTARY Switch

Part No.: **Q27003**

Customer:

DRW:	Jason	CHKD	Wilson	MATL:	Wilson	TOLERANCE	Mason	DATE	21.04.2017
APPD:	Schumi			FINISH	Jamy		Sheet No.	6 from 6	