

EDCON-COMPONENTS

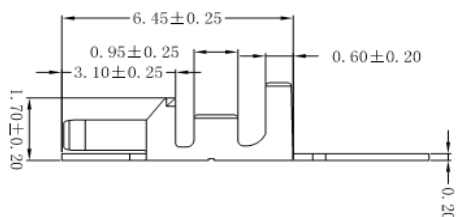

Specifications

Voltage Rating:	250V AC,DC
Current Rating	3A AC/DC
Operating Temperature	-25°C ~ + 85°C
Contact Resistance	30 milli Ohm max.
Withstanding Voltage	1000V AC/minute
Insulation Resistance	1000 M Ohm min.
Material Pin:	Phosphor Bronze
Contact Plating:	Tin or Gold Flash Plated

Drawing (dimensions all into mm)

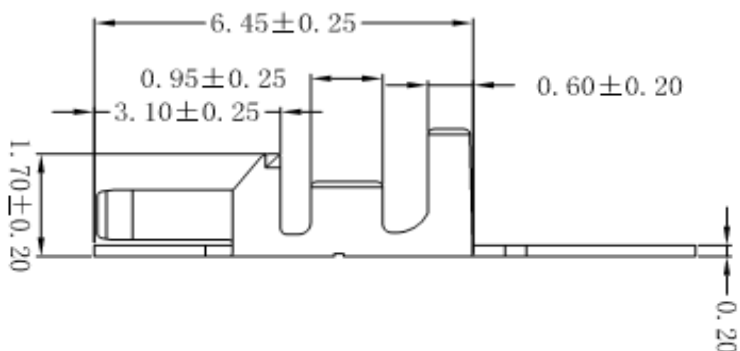
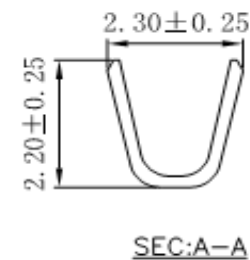
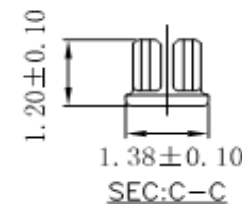
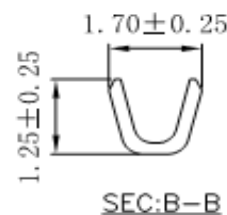
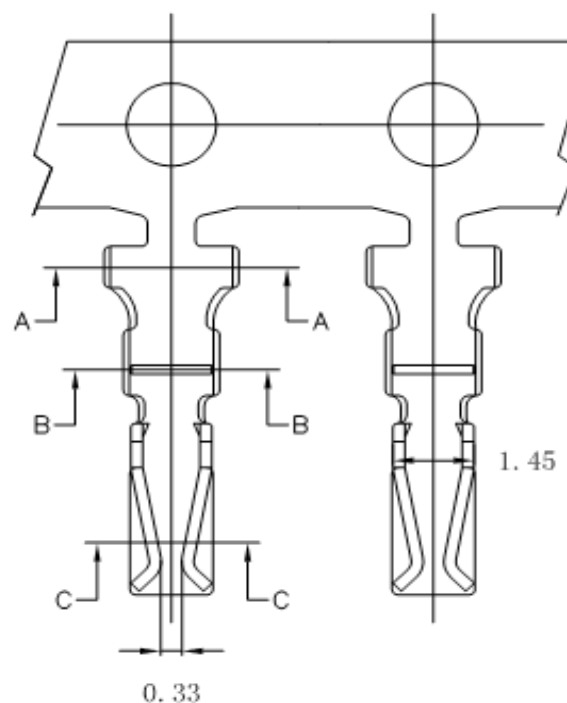

Housing Serie Pitch 2,00mm

Part No.: **T68T1011**

Customer:

DRW:	Jason	CHKD	Wilson	MATL:	Wilson	TOLERANCE	Mason	DATE	02.04.2009
APPD:	Schumi			FINISH	Jamy		Sheet No.	1 from 3	

www.edcon-components.com

email: info@edcon-components.com

EDCON-COMPONENTS

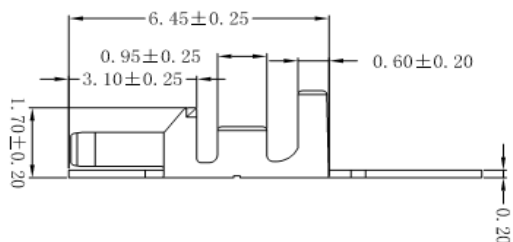

Ordering Informations

Serie	Contact plating	Wire Size	Packing							
-------	-----------------	-----------	---------	--	--	--	--	--	--	--

T68T1011	T	24	TR10K							
-----------------	----------	-----------	--------------	--	--	--	--	--	--	--

T= Tin	24 = AWG 24~ 28	TR= Tape/Reel 10000PCS								
G= Flash Gold										



Housing Serie Pitch 2,00mm	
Part No.:	T68T1011
Customer:	

DRW:	Jason	CHKD	Wilson	MATL:	Wilson	TOLERANCE	Mason	DATE	02.04.2009
APPD:	Schumi			FINISH	Jamy		Sheet No.		3 from 3

www.edcon-components.com

email: info@edcon-components.com