

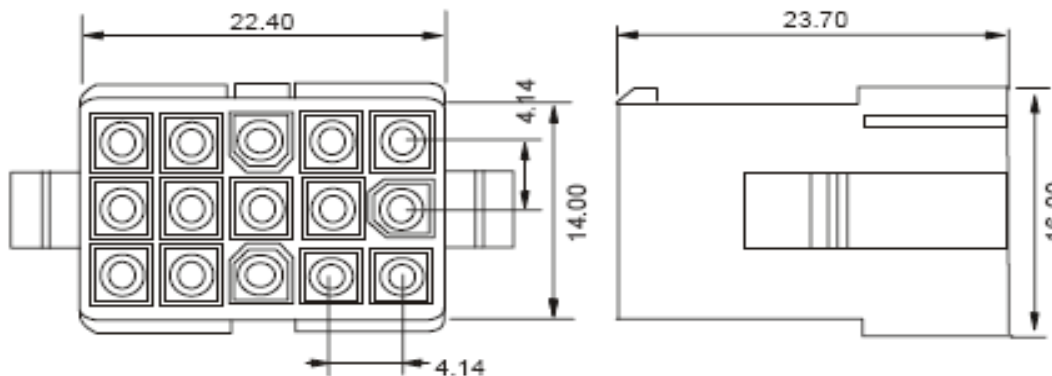

Specifications

Voltage Rating:	250 V AC/DC
Current Rating:	4A AC/DC
Operating Temperature:	. -25°C to + 85°C
Contact Resistance:	7milli Ohm
Withstanding Voltage:	1500 V AC/Minute
Insulation Resistance:	1000Mege Ohm min.
Applicable Wire:	AWG18 ~ 22
Material Housing:	Nylon 66 / UL94V-0

Drawing (dimensions all into mm)



Housing Serie T68Rxxxx Pitch
4,14mm

Part No.: **T68R1025**

Customer:

DRW:	Jason	CHKD	Wilson	MATL:	Wilson	TOLERANCE	Mason	DATE	02.04.2009
APPD:	Schumi			FINISH	Jamy		Sheet No.	1 from 3	



Ordering Informations

Serie	Number of Pos.	Ears mounting	Packing							
-------	----------------	---------------	---------	--	--	--	--	--	--	--

T68R1025	15	N	BU							
-----------------	-----------	----------	-----------	--	--	--	--	--	--	--

xx = Pos.	N= Without Ears	BU= Bulk Packing								
	Y= With Ears									



Housing Serie T68Rxxxx Pitch 4,14mm	
Part No.:	T68R1025
Customer:	

DRW:	Jason	CHKD	Wilson	MATL:	Wilson	TOLERANCE	Mason	DATE	02.04.2009
APPD:	Schumi			FINISH	Jamy		Sheet No.	3 from 3	