

# EDCON-COMPONENTS

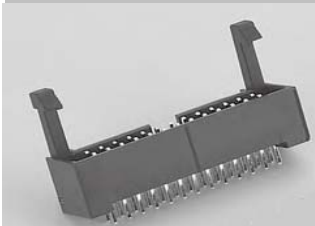

## Specifications

Current Rating:	2,0A
Insulation Resistance:	3000M Ohm min.
Contact Resistance:	20milli Ohm max.
Dielectric Voltage:	500V AC for one minute
Operating Temperature:	. -40°C ~ to +105°C
Insulator Material:	PBT, UL94V-0 glass reinforced
Latches Material:	PBT
Contact Pin:	Brass
Standard Contact Plating:	Gold Flash all over

## Drawing

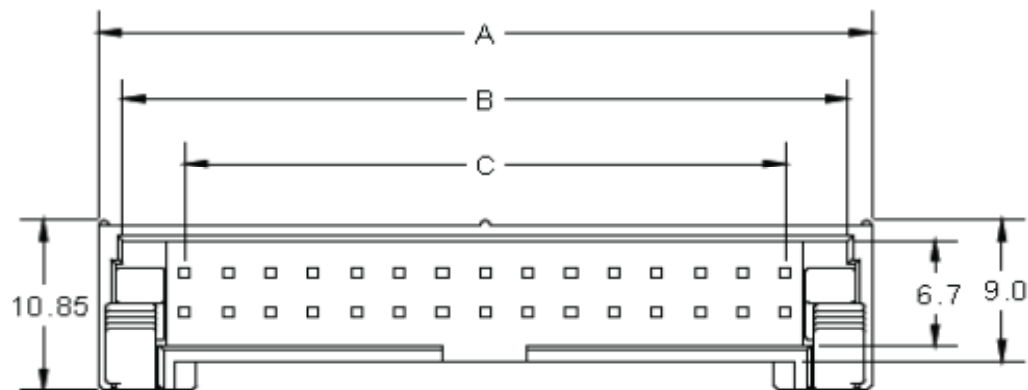

## PCB Layout

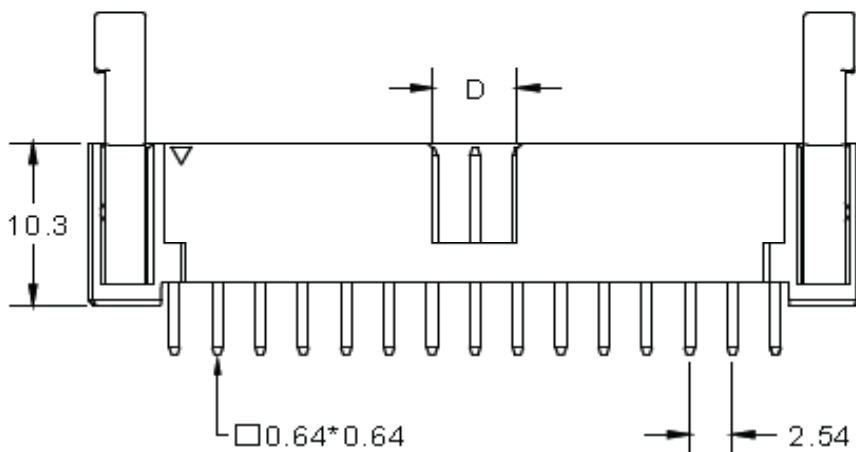
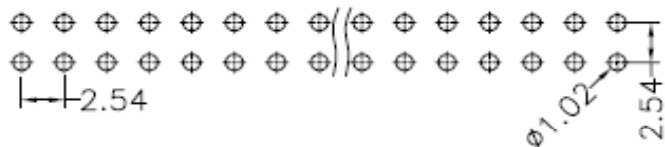

**Box Header w. Side Latch  
Pitch 2,54x2,54mm**

Part No.: **T16A028-**

Customer:

DRW:	Jason	CHKD	Wilson	MATL:	Wilson	TOLERANCE	Mason	DATE	16.06.2016
APPD:	Schumi			FINISH	Jamy		Sheet No.	1 from 4	

# EDCON-COMPONENTS

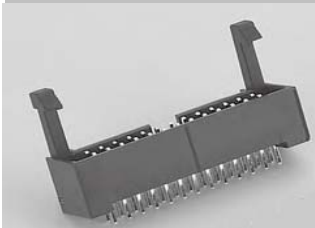

## Pin Code length table free configuration

Dimension ( mm)				
	A			
A01	3,20			
A02				
A03				
A04				
A05				
A06				
A07				
A08				
A09				
A10				
A11				
A12				
A13				
A14				
A15				
A16				
A17				
A18				
A19				
A20				
A21				
A22				

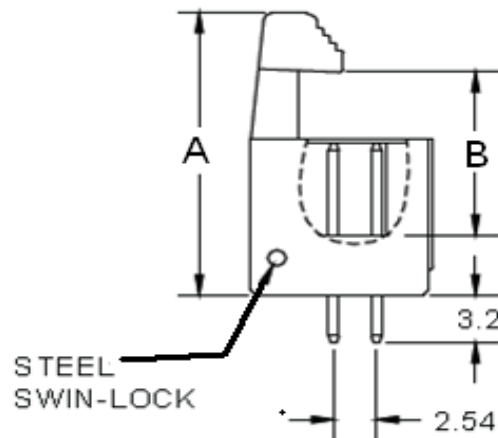

Latches Dimension (mm)		
Latches	A	B
Short- Type	18,7	10,6
Long -Tpe	22,1	14,5

Dimension (mm)				
Position	A	B	C	D
6	15,29	12,41	5,08	2,30
8	17,83	14,95	7,62	2,30
10	20,37	17,49	10,16	5,00
12	22,91	20,03	12,70	5,00
14	25,45	22,57	15,24	5,00
16	27,99	25,11	17,78	5,00
20	33,07	30,19	22,86	5,00
24	38,15	35,27	27,94	5,00
26	40,69	37,81	30,48	5,00
30	45,77	42,89	35,56	5,00
34	50,85	47,97	40,64	5,00
40	58,47	55,59	48,26	5,00
50	71,17	68,29	60,96	5,00
60	83,87	81,01	73,66	5,00
64	88,95	86,07	78,74	5,00

<b>Box Header w. Side Latch</b>	
<b>Pitch 2,54x2,54mm</b>	
Part No.:	<b>T16A028-</b>
Customer:	

DRW:	Jason	CHKD	Wilson	MATL:	Wilson	TOLERANCE	Mason	DATE	16.06.2016
APPD:	Schumi			FINISH	Jamy		Sheet No.		2 from 4

[www.edcon-components.com](http://www.edcon-components.com)

email: [info@edcon-components.com](mailto:info@edcon-components.com)

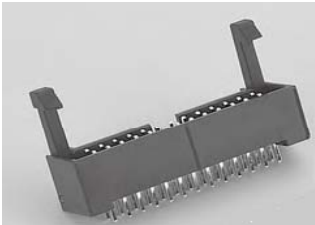

**Ordering Informations**

Serie	No. of Pos.	Contact Plating	Material	Color of Body	Pin Length Configuration	Latches Type	ROHS	Packing		
<b>T16A028-</b>	<b>XX</b>	<b>G0</b>	<b>PB</b>	<b>BK</b>	<b>A01</b>	<b>S</b>	<b>R</b>	<b>BU</b>		

<b>XX=</b> 6, 8, 10, 12, 14, 16, 20, 24, 26, 30, 34, 40, 50, 60, 64	<b>G0=</b> Gold Flash	<b>PB=</b> PBT	<b>BK=</b> Black	<b>Axx=</b> Look Table	<b>S=</b> Short Latch	<b>N=</b> NO ROHS	<b>BU=</b> Bulk Ware
	<b>T0=</b> Tin plated	<b>PA=</b> PA6T + 30% GF					
	<b>GA=</b> 3µ Gold Plating						<b>TY=</b> Tray
	<b>GB=</b> 5µ Gold Plating						
	<b>GC=</b> 10µ Gold Plating						
	<b>GD=</b> 30µ Gold Plating						
	<b>S0=</b> Selectiv Plating Gold Flash / Tin						
	<b>SD=</b> Selectiv Tin/ 5µGold						
	<b>SD=</b> Selectiv Tin/ 10µ Gold Flash						
	<b>SD=</b> Selectiv Tin/ 20µ Gold	<b>SD=</b> Selectiv Tin/ 30µ Gold					

<b>Box Header w. Side Latch</b> <b>Pitch 2,54x2,54mm</b>
Part No.: <b>T16A028-</b>
Customer:

DRW:	Jason	CHKD	Wilson	MATL:	Wilson	TOLERANCE	Mason	DATE	16.06.2016
APPD:	Schumi			FINISH	Jamy		Sheet No.		3 from 4

[www.edcon-components.com](http://www.edcon-components.com)

email: [info@edcon-components.com](mailto:info@edcon-components.com)

Copyright by S.Tiede

**EDCON-COMPONENTS**



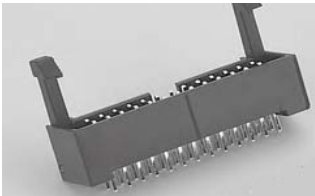

**Soldering Profile for Lead Soldering ( P.B.T. )**

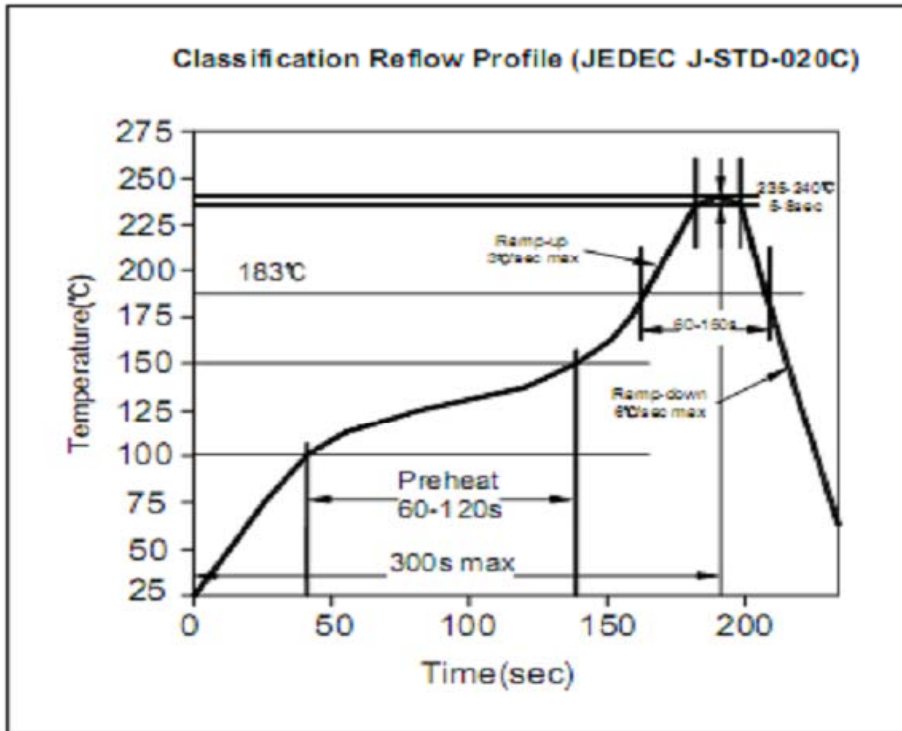

**Soldering Profile for Lead Free Soldering ( Nylon 6T )**

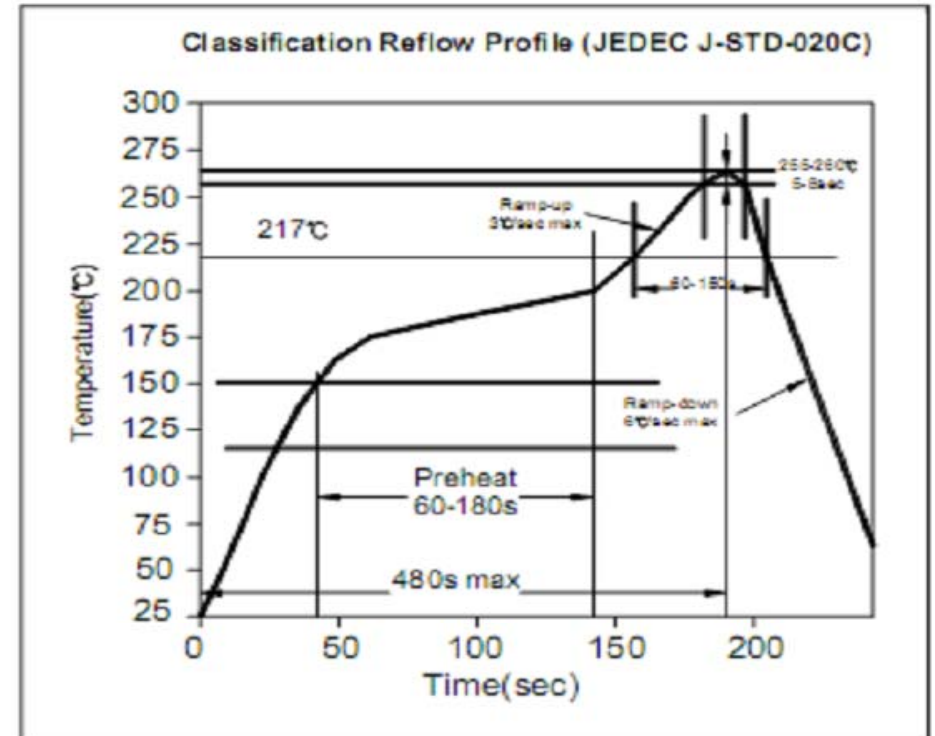

**Box Header w. Side Latch  
Pitch 2,54x2,54mm**

Part No.: **T16A028-**

DRW:	Jason	CHKD	Wilson	MATL:	Wilson	TOLERANCE	Mason	DATE	16.06.2016
APPD:	Schumi			FINISH	Jamy		Sheet No.	4 from 4	

Customer: