

EDCON-COMPONENTS

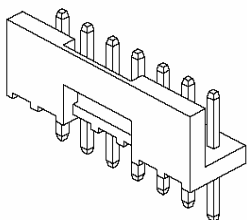

Specifications

Voltage Rating: 250 V AC/DC
 Current Rating: 3A AC/DC
 Operating Temperature: -40°C to + 105°C
 Contact Resistance: 10 mΩ
 Withstanding Voltage: 800 V AC/Minute
 Insulation Resistance: 1000MΩ min.
 Material Housing: PBT30% GF, UL94V-0

Pin-Material: Brass /Tin-plated
 Color of Base: Natural

Drawing (dimensions all into mm)

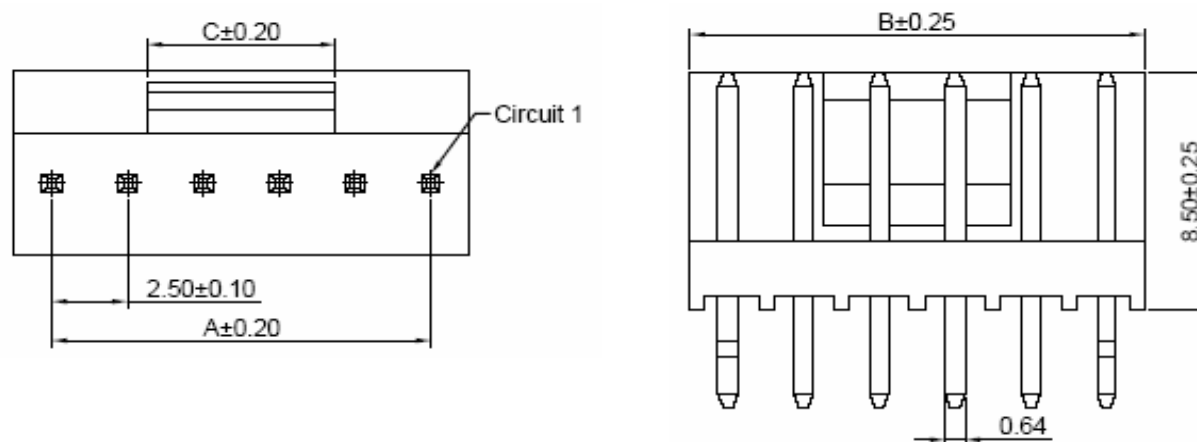

P.C.B. Layout

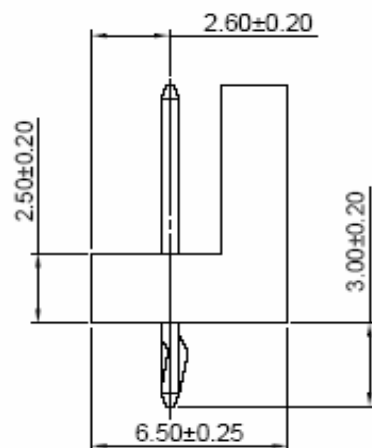
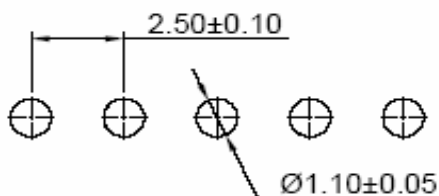

Unit: mm

Wafer Serie T68Pxxxx Pitch
2,50mm

Part No.: **T68P096**

DRW:	Jason	CHKD	Wilson	MATL:	Wilson	TOLERANCE	Mason	DATE	09.05.2012
APPD:	Schumi			FINISH	Jamy		Sheet No.		1 from 4

Customer:

EDCON-COMPONENTS

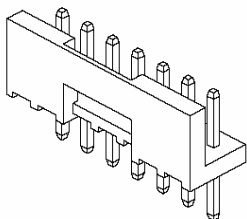

Ordering Informations

Serie	Number of Pos.	Special function	Color of Body	Packing						
T68P096	02	X	NA	BU						
	xx = Pos.	X= no function	NA= Natural (Standard)	BU= Bulk Ware						

Wafer Serie T68Pxxxx Pitch 2,50mm

Part No.: **T68P096**

DRW:	Jason	CHKD	Wilson	MATL:	Wilson	TOLERANCE	Mason	DATE	09.05.2012
APPD:	Schumi			FINISH	Jamy			Sheet No.	3 from 4

Customer:

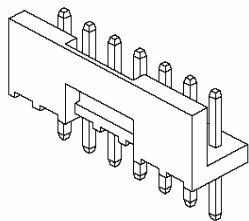

Soldering Profile Curve

Classification Reflow Profile (JEDEC J-STD-020C)

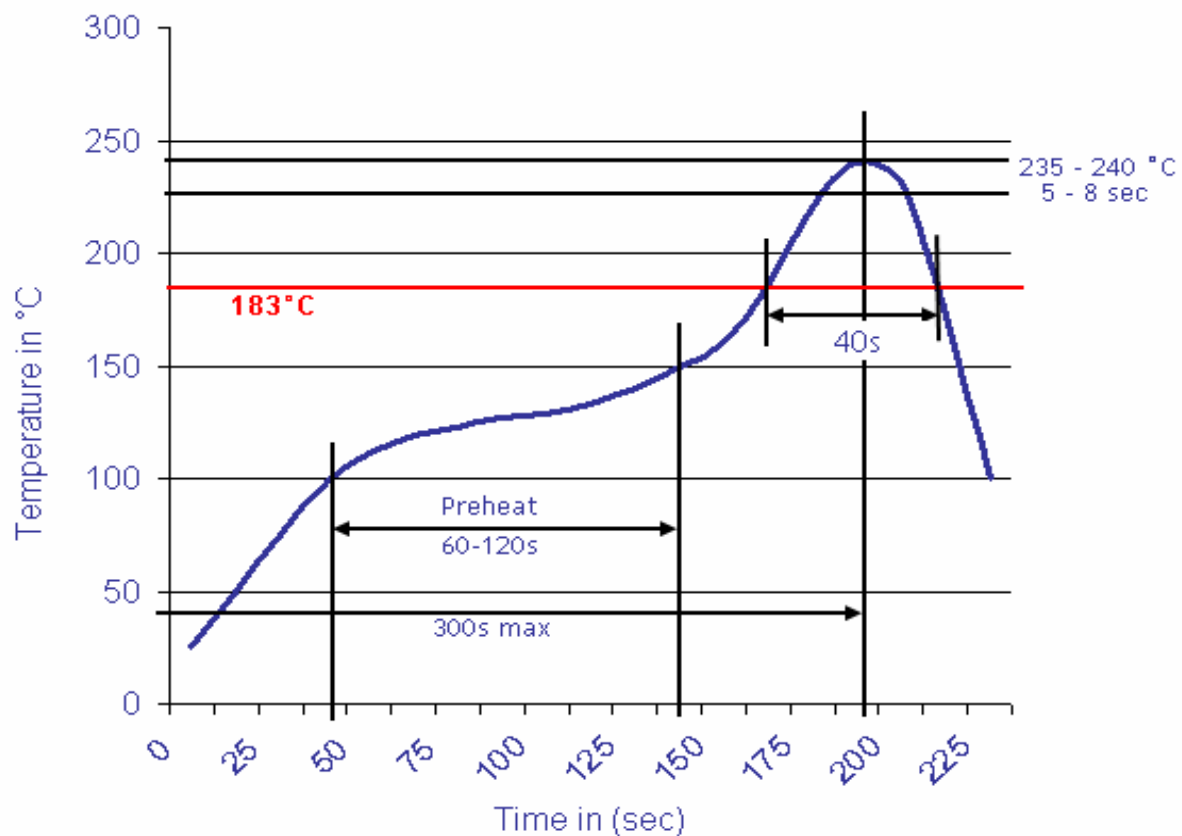

Wafer Serie T68Pxxxx Pitch
2,50mm

Part No.: **T68P096**

DRW:	Jason	CHKD	Wilson	MATL:	Wilson	TOLERANCE	Mason	DATE	09.05.2012
APPD:	Schumi			FINISH	Jamy		Sheet No.	4 from 4	

Customer:

email: info@edcon-components.com