

EDCON-COMPONENTS



Specifications

Rated Voltage:	12 VDC
Operating Voltage:	3~24VDC
Rated Current:	10mA max.
Typical Sound Output:	90B min.
Resonant Frequency	3700Hz +/-500Hz
Tone	Continuos
Operating Temperature:	. -20°C to +70°C
Storage Temperature:	. -30°C to +80°C
Weight	11,8 gr.

Life Test	Operate the part at 12VDC in room temeprature continuously 1000hrs
Operating Temperature	Driving from -20°to +70°C within 30minutes for 2 cyc les
High Temperature	. +85°C +/-2°C, 120hours
Low Temperature	. -30°C +/-2°C, 120hours
Humidity	.+ 60°C +/-2°C, 90-95% RH, 120hours
Thermal Shock	. -20°C / +/- 2°C, 1hr> +20°C, 5min, > +70°C +/-2°C , 1hr> +20°C, 5min 5cycles
Shock	980/s ² (=100g) shock for each 3 mutually perpendicular directions to each of 3 times by half sine wave.
Vibration	1,5mm with 10 to 50Hz of vibration frequency to each of 3perpendicular direction for 2 hrs.
Drop Test	Dropped naturally from 700mm height onto the surface of 10mm thick wooden board. 2 directions- upper and side of the part are to be applied

Features

Reliable Solid State Piezoelectric Technology
Corrosion Resistance Diaphragm
Flame Retardant Plastic

Applications

Automatic Control Equipment
Communication Equipment
Electronic Instruments

Warranty

All specifications must be satisfied after the test (Recovery: 2 to 4 hrs of recovery under the standard condition after the removal from test chamber).

THT Piezo Buzzer

Part No.: **I19017**

Customer:

DRW:	Jason	CHKD	Wilson	MATL:	Wilson	TOLERANCE	Mason	DATE	10.06.2010
APPD:	Schumi			FINISH	Jamy		Sheet No.		1 from 4

www.edcon-components.com

email: info@edcon-components.com

EDCON-COMPONENTS



Dimensions (mm)

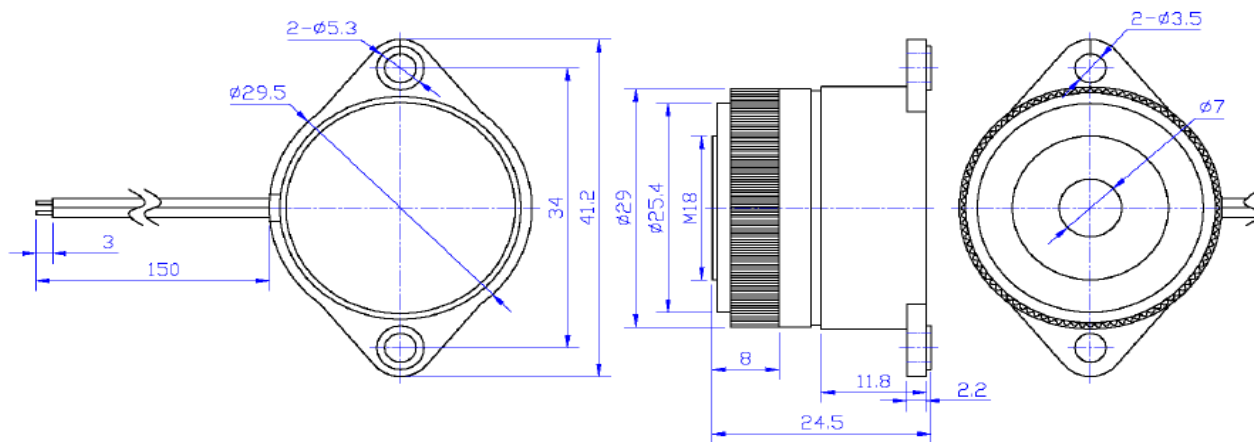

Characteristics



THT Piezo Buzzer

Part No.: **I19017**

Customer:

DRW:	Jason	CHKD	Wilson	MATL:	Wilson	TOLERANCE	Mason	DATE	10.06.2010
APPD:	Schumi			FINISH	Jamy		Sheet No.	2 from 4	

www.edcon-components.com

email: info@edcon-components.com

EDCON-COMPONENTS



Ordering Informations

Serie	Model-No.	ROHS	Package						
I19017	30C123.7W150	R	TY						

R = ROHS Conform	TY = Tray Packing
N = NON ROHS Conform	BU = Tube Packing

THT Piezo Buzzer	
Part No.:	I19017
Customer:	

DRW:	Jason	CHKD	Wilson	MATL:	Wilson	TOLERANCE	Mason	DATE	10.06.2010
APPD:	Schumi			FINISH	Jamy		Sheet No.		3 from 4



Soldering Profile Curve

Classification Reflow Profile (JEDEC J-STD-020C)

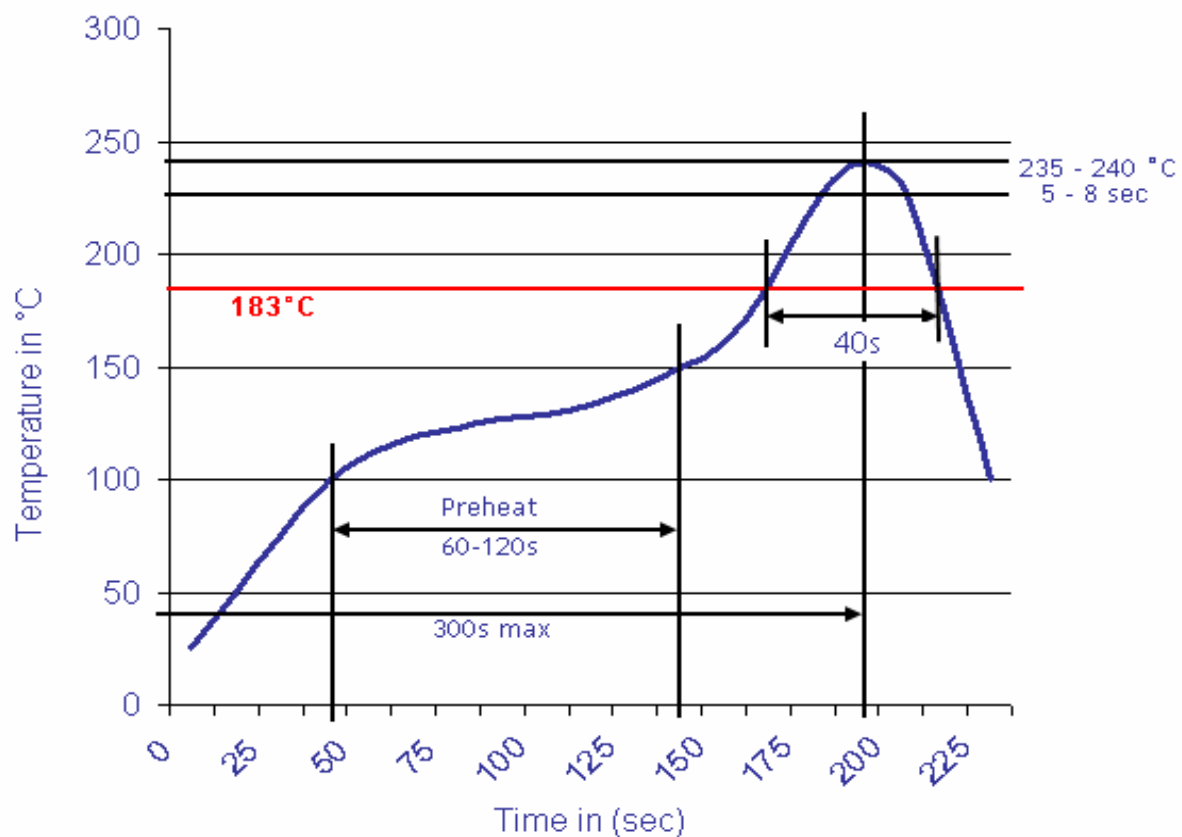

THT Piezo Buzzer	
Part No.:	I19017
Customer:	

DRW:	Jason	CHKD	Wilson	MATL:	Wilson	TOLERANCE	Mason	DATE	10.06.2010
APPD:	Schumi			FINISH	Jamy		Sheet No.	4 from 4	