

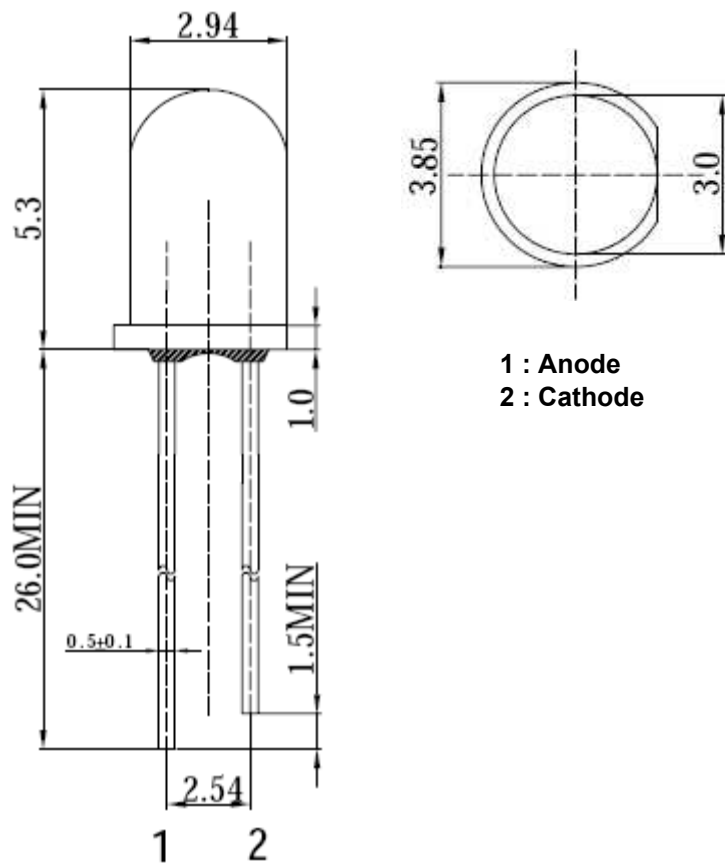

**Applications**

- Electronic Signs and Signals
- Small Area Illuminations
- Back Lighting
- Other Lighting

**Technical Drawing**



1 : Anode  
 2 : Cathode

**Notes :**

All dimensions in mm tolerance is  $\pm 0.1$ mm unless otherwise noted.

<b>Round LED Yellow</b>	
Part No.:	<b>M13A2022</b>
Customer:	

DRW:	Dong	CHKD	Chang	MATL:	Chui	DATE	30.06.2010
APPD:	Ping			FINISH	Hui	Sheet	1 from 6



**Absolute Maximum Ratings**

Item	Symbol	AlGaInP	Unit
Power Dissipation	P <sub>D</sub>	140	mW
DC Forward Current	I <sub>F</sub>	30	mA
Pulsed Forward Current	I <sub>FP</sub> *	100	mA
Reverse Voltage	V <sub>R</sub>	5	V
Operating Temperature	T <sub>OP</sub>	-40 to 80	°C
Storage Temperature	T <sub>ST</sub>	-40 to 100	°C

\* 0.1 msec pulse, 10% duty cycle

**Electrical / Optical Characteristics**

<b>Emitting Color</b>	Yellow		
<b>Material</b>	AlGaInP		
<b>Forward Voltage</b>	typ.	1.9	V <sub>F</sub>
	max.	2.3	V <sub>F</sub>
<b>Wavelength typ.</b>	λ <sub>D</sub>	580	nm
	λ <sub>P</sub>	595	nm
	Δλ	---	nm
<b>Color Temperature</b>	min.	---	K
	max.	---	K
<b>Luminous Intensity *</b>	min.	10000	mcd
	typ.	15000	mcd
<b>Reverse Current</b>	max.	---	μA
<b>Viewing Angle</b>	2θ <sub>1/2</sub>	25	

\* Per NIST standards

**Round LED**  
**Yellow**

Part No.: **M13A2022**

Customer:

DRW:	Dong	CHKD	Chang	MATL:	Chui	DATE	30.06.2010
APPD:	Ping			FINISH	Hui	Sheet	2 from 6



### Directive Characteristics

**Round LED  
Yellow**

Part No.: **M13A2022**

Customer:

DRW:	Dong	CHKD	Chang	MATL:	Chui	DATE	30.06.2010
APPD:	Ping			FINISH	Hui	Sheet	3 from 6

Copyright by EDCON-COMPONENTS



**Curve**

Relative Intensity VS. Ambient Temp



Forward Current VS. Ambient Temp

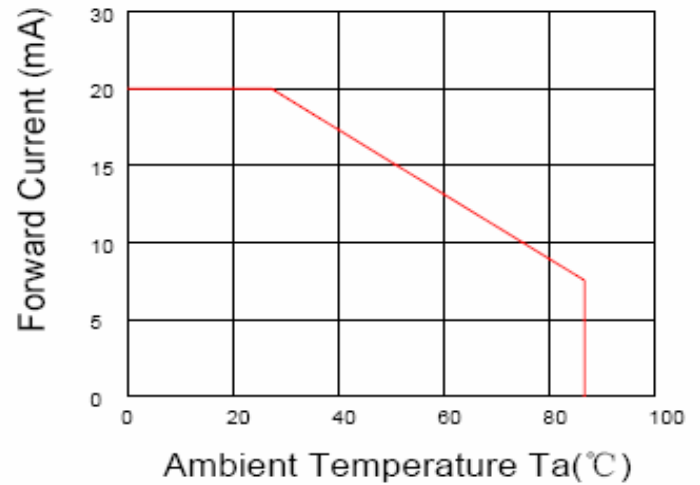

Forward Current VS. Relative Intensity



**Round LED**  
**Yellow**

Part No.: **M13A2022**

Customer:

DRW:	Dong	CHKD	Chang	MATL:	Chui	DATE	30.06.2010
APPD:	Ping			FINISH	Hui	Sheet	4 from 6



**Solder Condition**

**Lead Free Solder**



<b>Round LED Yellow</b>	
Part No.:	<b>M13A2022</b>
Customer:	

DRW:	Dong	CHKD	Chang	MATL:	Chui	DATE	30.06.2010
APPD:	Ping			FINISH	Hui	Sheet	5 from 6



**Color table curve**

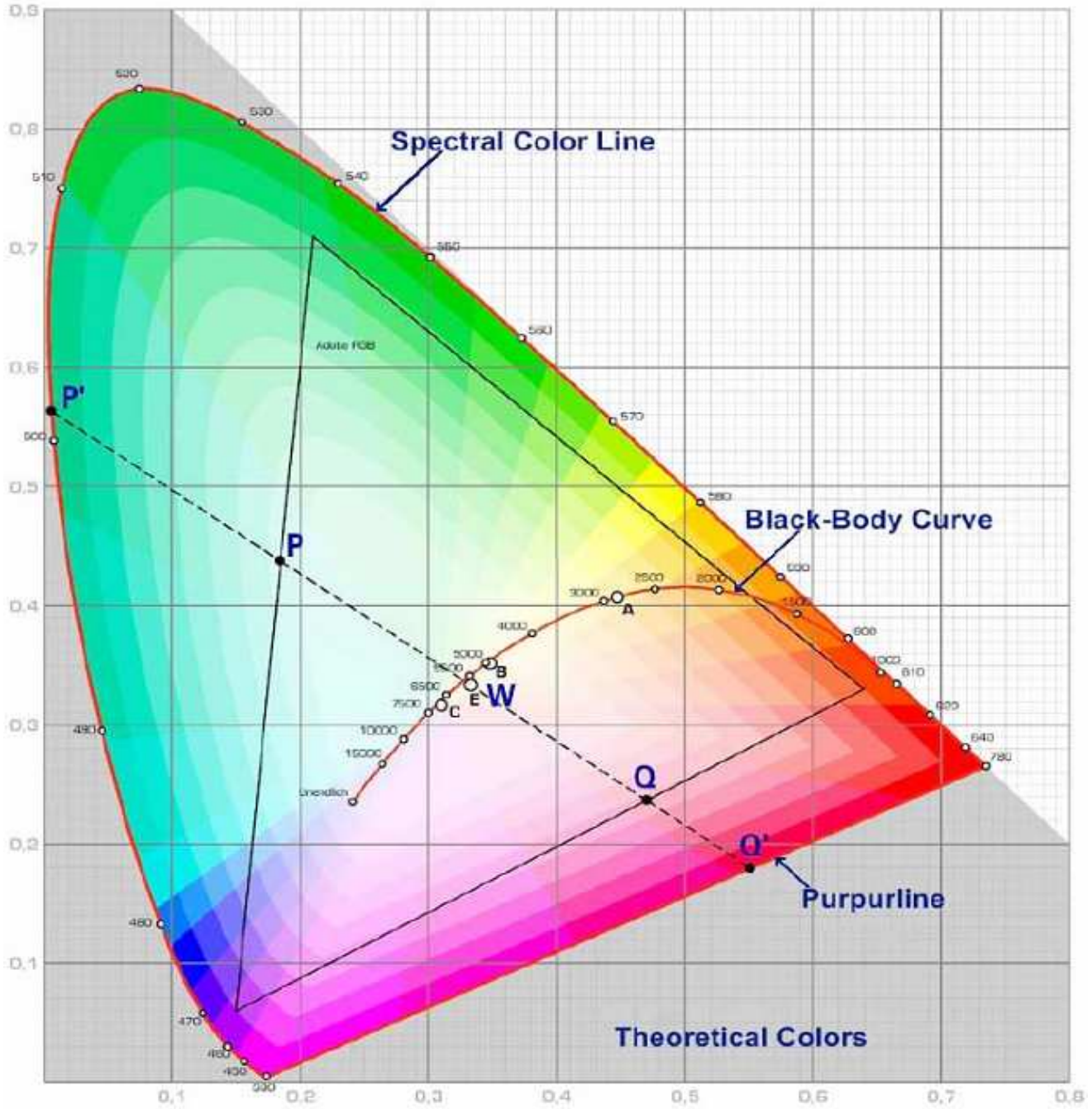

<b>Round LED Yellow</b>	
Part No.:	<b>M13A2022</b>
Customer:	

DRW:	Dong	CHKD	Chang	MATL:	Chui	DATE	30.06.2010
APPD:	Ping			FINISH	Hui	Sheet	6 from 6

Copyright by EDCON-COMPONENTS