

**Applications**

- Interior automotive lighting
- Optical indicators
- Communication Products
- Backlighting
- Toys

**Technical Drawing**

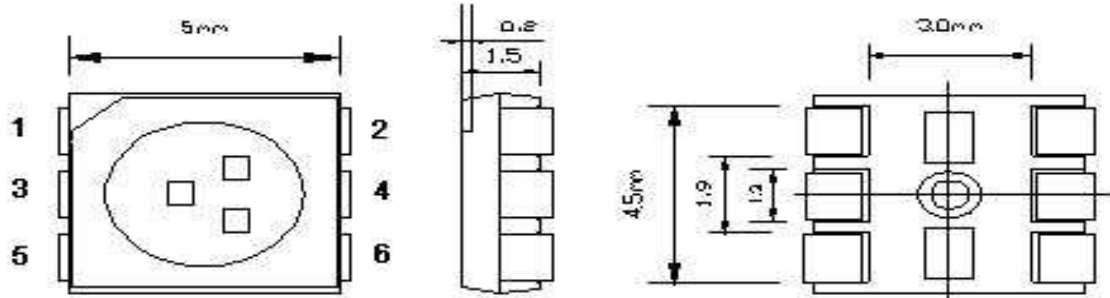

**Recommended Soldering Pattern**

**Notes :**

All dimensions in mm tolerance is  $\pm 0.1\text{mm}$  unless otherwise noted.

<b>PLCC6</b> <b>White</b>	
Part No.:	<b>M11A5019</b>
Customer:	

DRW:	Dong	CHKD	Chang	MATL:	Chui	DATE	22.06.2010
APPD:	Ping			FINISH	Hui	Sheet	1 from 9



**Absolute Maximum Ratings**

Item	Symbol	InGaN	Unit
Power Dissipation	$P_D$	---	mW
DC Forward Current	$I_F$	---	mA
Pulsed Forward Current	$I_{FP}^*$	---	mA
Reverse Voltage	$V_R$	---	V
Operating Temperature	$T_{OP}$	---	°C
Storage Temperature	$T_{ST}$	---	°C

\* 0.1 msec pulse, 10% duty cycle

**Electrical / Optical Characteristics**

$I_F=20mA$

Ermitting Color	White		
Material	InGaN		
Forward Voltage	typ.	3.0	$V_F$
	max.	3.6	$V_F$
Wavelength typ.	$\lambda_D$	---	nm
	$\lambda_P$	---	nm
	$\Delta\lambda$	---	nm
Color Temperature	min.	5000	K
	max.	7000	K
Luminous Intensity *	min.	4000	mcd
	typ.	5000	mcd
Reverse Current	max.	---	$\mu A$
Viewing Angle	2 $\Theta$ 1/2	120	

\* Per NIST standards

<b>PLCC6</b> <b>White</b>	
Part No.:	<b>M11A5019</b>
Customer:	

DRW:	Dong	CHKD	Chang	MATL:	Chui	DATE	22.06.2010
APPD:	Ping			FINISH	Hui	Sheet	2 from 9

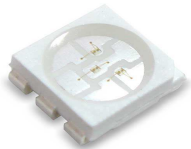

### Directive Characteristics

**PLCC6**  
**White**

Part No.: **M11A5019**

Customer:

DRW:	Dong	CHKD	Chang	MATL:	Chui	DATE	22.06.2010
APPD:	Ping			FINISH	Hui	Sheet	3 from 9

Copyright by EDCON-COMPONENTS



**Curvs**

**PLCC6**  
**White**

Part No.: **M11A5019**

Customer:

DRW:	Dong	CHKD	Chang	MATL:	Chui	DATE	22.06.2010
APPD:	Ping			FINISH	Hui	Sheet	4 from 9

Copyright by EDCON-COMPONENTS

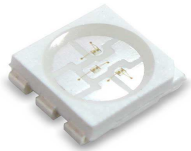

**Solder Condition**

**Lead Free Solder**

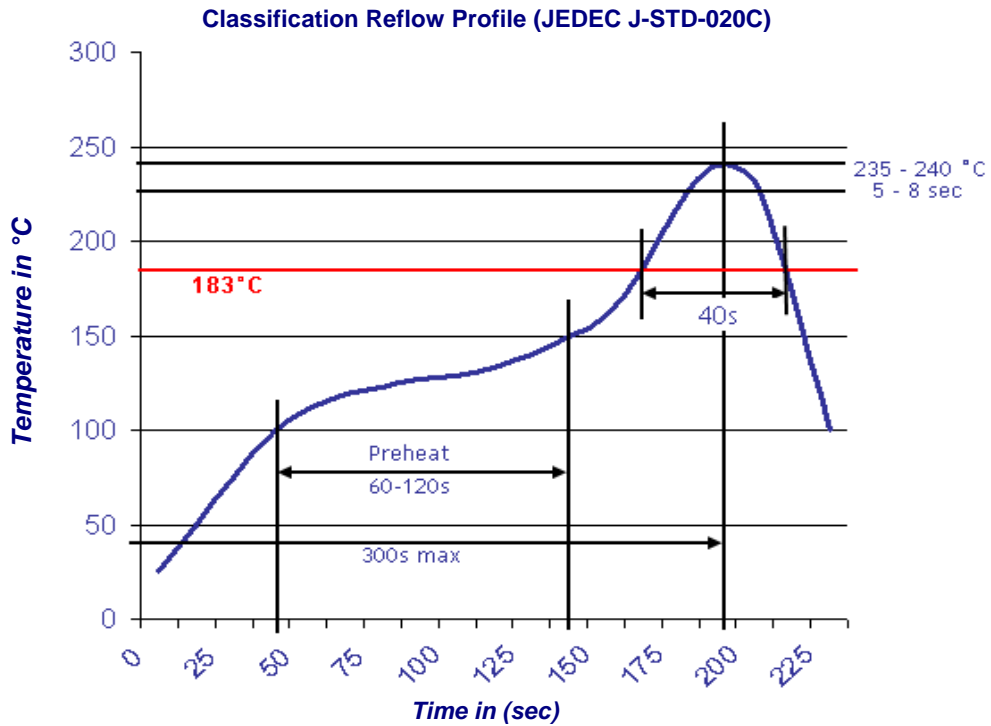

<b>PLCC6 White</b>	
Part No.:	<b>M11A5019</b>
Customer:	

DRW:	Dong	CHKD	Chang	MATL:	Chui	DATE	22.06.2010
APPD:	Ping			FINISH	Hui	Sheet	5 from 9

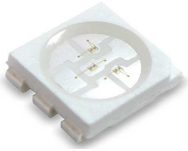

**Packing Specifications**

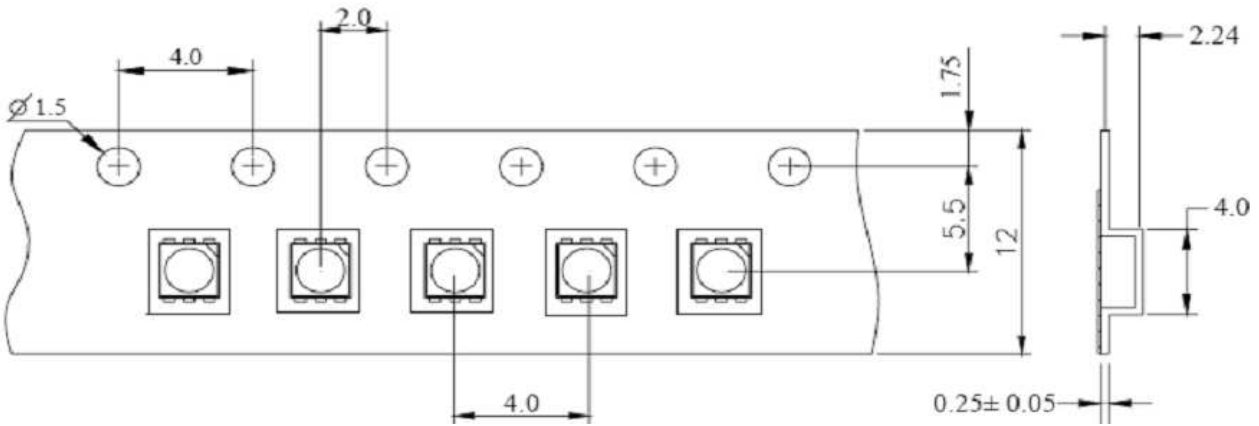

**Reel Specifications**

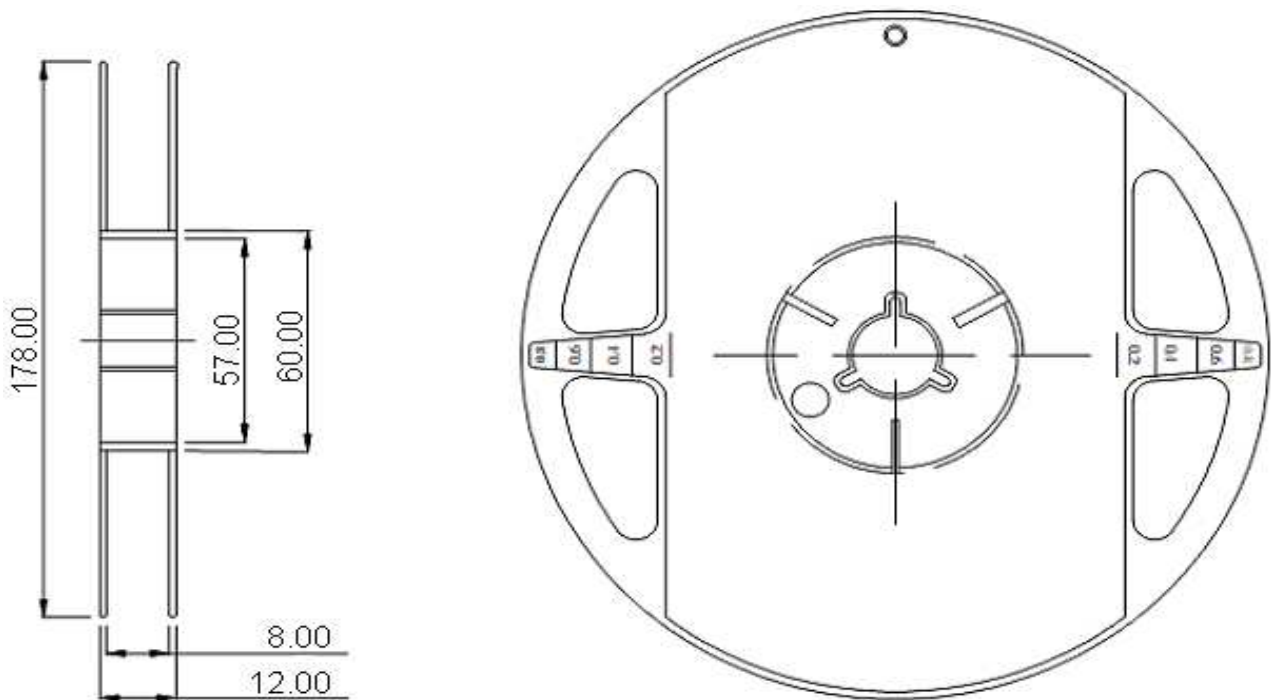

**PLCC6**  
**White**

Part No.: **M11A5019**

Customer:

DRW:	Dong	CHKD	Chang	MATL:	Chui	DATE	22.06.2010
APPD:	Ping			FINISH	Hui	Sheet	6 from 9



### Handling Precautions

Compare to epoxy encapsulant that is hard and brittle, silicone is softer and flexible. Although its characteristic significantly reduces thermal stress, it is more susceptible to damage by external mechanical force. As a result, special handling precautions need to be observed during assembly using silicone encapsulated LED products. Failure to comply might lead to damage and premature failure of the LED.

1. Handle the component along the side surfaces by using forceps or appropriate tools

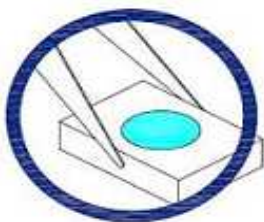

2. Do not directly touch or handle the silicone lens surface. It may damage the internal circuitry.



3. Do not stack together assembled PCBs containing exposed LEDs. Outside impact may scratch the silicone lens or damage the internal circuitry.



**PLCC6**  
**White**

Part No.: **M11A5019**

Customer:

DRW:	Dong	CHKD	Chang	MATL:	Chui	DATE	22.06.2010
APPD:	Ping			FINISH	Hui	Sheet	7 from 9

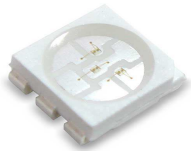

4. The outer diameter of the TOP LED pickup nozzle should not exceed the size of the LED to prevent air leaks. The inner diameter of the nozzle should be as large as possible.
5. A pliable material is suggested for the nozzle tip to avoid scratching or damaging the LED surface during pickup.
6. The dimensions of the component must be accurately programmed in the pick-and-place machine to insure precise pickup and avoid damage during production.



<b>PLCC6</b> <b>White</b>	
Part No.:	<b>M11A5019</b>
Customer:	

DRW:	Dong	CHKD	Chang	MATL:	Chui	DATE	22.06.2010
APPD:	Ping			FINISH	Hui	Sheet	8 from 9

Copyright by EDCON-COMPONENTS



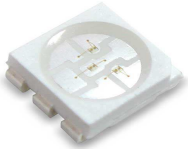

**Color table curve**

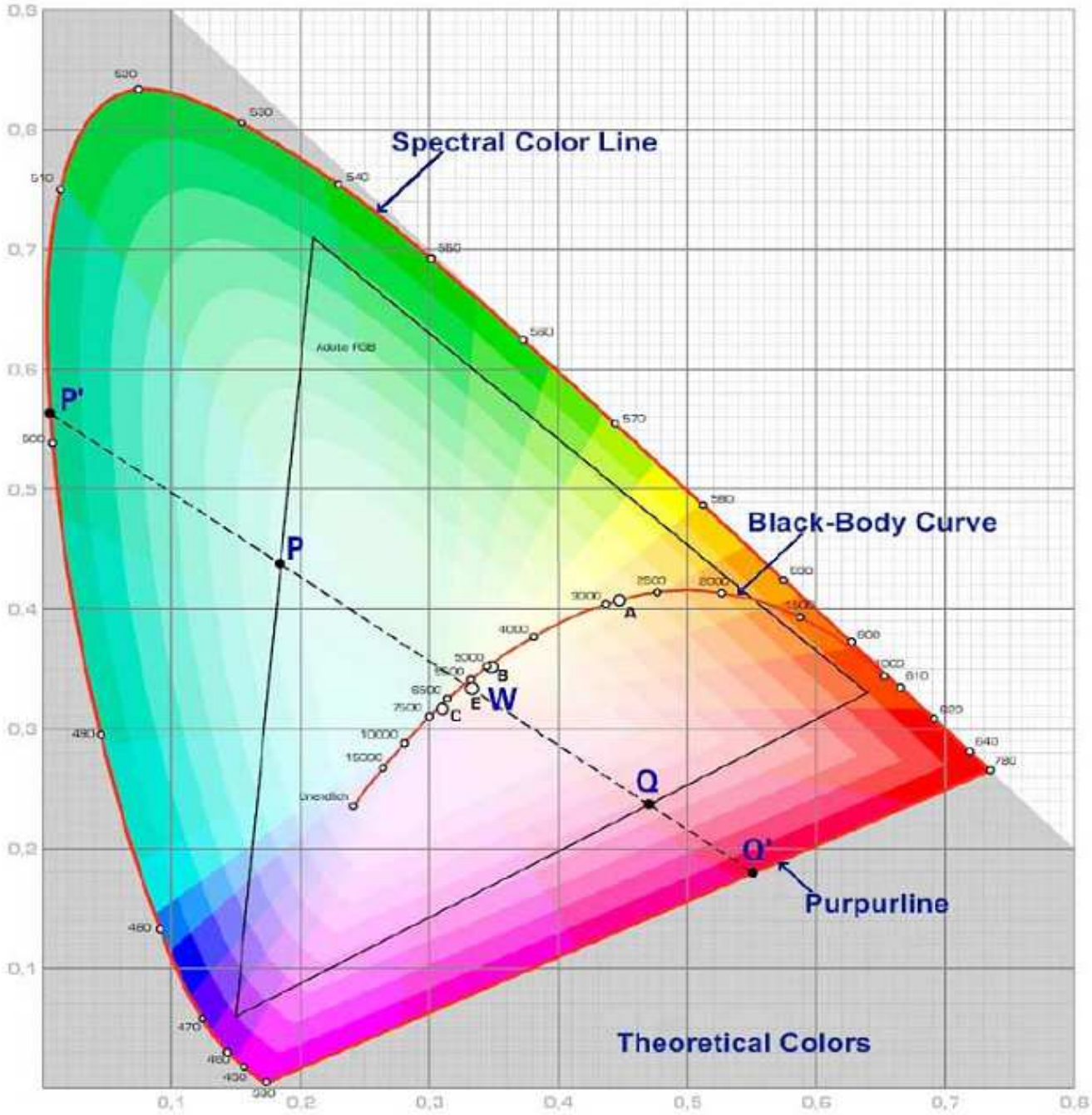

<b>PLCC6 White</b>	
Part No.:	<b>M11A5019</b>
Customer:	

DRW:	Dong	CHKD	Chang	MATL:	Chui	DATE	22.06.2010
APPD:	Ping			FINISH	Hui	Sheet	9 from 9

Copyright by EDCON-COMPONENTS