

EDCON-COMPONENTS



Specifications

Switch Rating:	Ith=5A Ui=250VAC
Contact Configuration:	1NO1NC
Operating Type:	Momentary / Alternate
IP-Degree:	IP65
Crust Material:	Stainless Steel
Terminal Type:	Pin Terminal (2,8x0,5mm)
Switching:	Two/Three Position Remain
Contact Resistance:	≤ 50mΩ
Insulation Resistance:	≥ 1000MΩ
Dielectric Strength:	2000VAC
Operating Temperature:	. -20°C ~ +55°C
Mechanical Life:	1.00.000 cycles
Electrical Life:	50.000 cycles
Panel Thickness:	1 ~ 6mm
Torque:	5 ~ 14Nm
Operating Pressure:	5,5Nm
Operating Distance:	About 2,5Nm

Material

Contact:	Silver Alloy
Button:	Stainless Steel
Body:	Stainless Steel
Base:	PBT
ROHS:	Made to Order-Code

Drawing

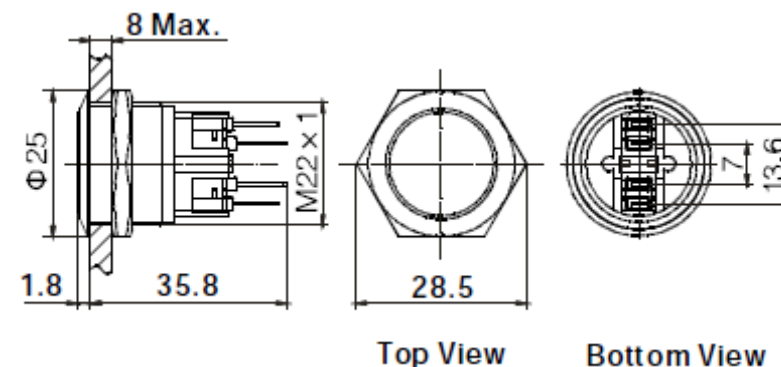

22MM Anti-Vandal-Switch

Part No.: **Q36032**

Customer:

DRW:	Jason	CHKD	Wilson	MATL:	Wilson	TOLERANCE	Mason	DATE	15.01.2016
APPD:	Schumi			FINISH	Jamy		Sheet No.	1 from 3	

EDCON-COMPONENTS



Visual Effect



Nickel - plated brass
(Satin surface)



Stainless steel (Spiral surface)



Gold - plated brass (Satin surface)

Engraving Options

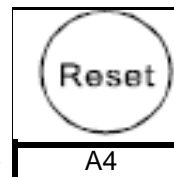

Order Code

A4

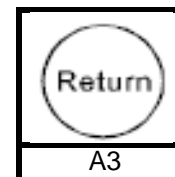

A3

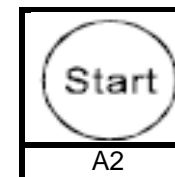

A2

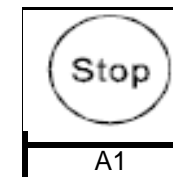

A1

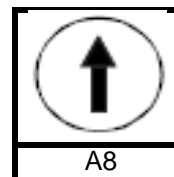

Order Code

A8

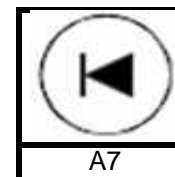

A7

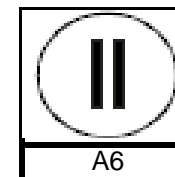

A6

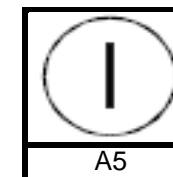

A5

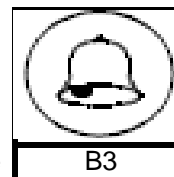

Order Code

B3

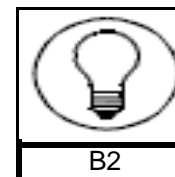

B2

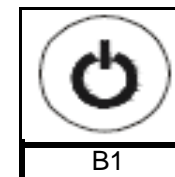

B1

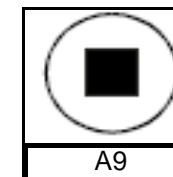

A9

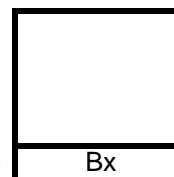

Order Code

Bx

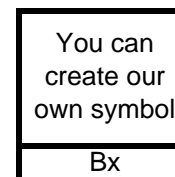

You can create our own symbol

Bx

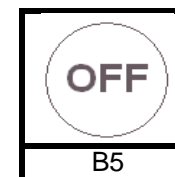

OFF

B5

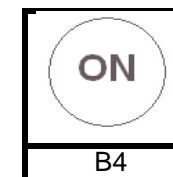

ON

B4

22MM Anti-Vandal-Switch

Part No.: **Q36032**

DRW:	Jason	CHKD	Wilson	MATL:	Wilson	TOLERANCE	Mason	DATE	15.01.2016	Customer:
APPD:	Schumi			FINISH	Jamy		Sheet No.		2 from 3	

EDCON-COMPONENTS



Ordering Informations

Serie	Front Shape	Contact Structure	Lamp Type	Connect Type	Lamp Color	Lamp Voltage	Crust Material	Engraving Options	Operating Type	ROHS	Packing Style
Q36032	F	11	N	3	A	0	S	XX	M	R	N

F= Flat	11= 1NO1NC	N= no Function	3= Pin Terminal	A= No Function	0= without	S= Stainless Steel	XX= Look Order Code Engraving Options	M= Momentary	R= ROHS Conform	N= White Carton
						N= Nickel Plated Brass		A= Alternate	N= NON ROHS Conform	I= Individual Packing
						G= Gold Plated Brass				

22MM Anti-Vandal-Switch

Part No.: **Q36032**

DRW:	Jason	CHKD	Wilson	MATL:	Wilson	TOLERANCE	Mason	DATE	15.01.2016	Customer:
APPD:	Schumi			FINISH	Jamy		Sheet No.	3 from 3		

www.edcon-components.com

email: info@edcon-components.com