

EDCON-COMPONENTS



Specifications

Switch Rating:	Ith=5A Ui=250VAC
Contact Configuration:	1NO1NC / 2NO2NC / 3NO3NC
Operating Type:	Momentary / Alternate
IP-Degree:	IP67
Crust Material:	Stainless Steel
Terminal Type:	Pin Terminal (2,8x0,5mm)
Switching:	Two/Three Position Remain
Contact Resistance:	≤ 50mΩ
Insulation Resistance:	≥ 1000MΩ
Dielectric Strength:	2000VAC
Operating Temperature:	. -20°C ~ +55°C
Mechanical Life:	1.00.000 cycles
Electrical Life:	50.000 cycles
Panel Thickness:	1 ~ 6mm
Torque:	5 ~ 14Nm
Operating Pressure:	5,5 ~ 8Nm
Operating Distance:	About 3,1Nm

Material

Contact:	Silver Alloy
Button:	Stainless Steel
Body:	Stainless Steel
Base:	PBT
ROHS:	Made to Order-Code

Drawing

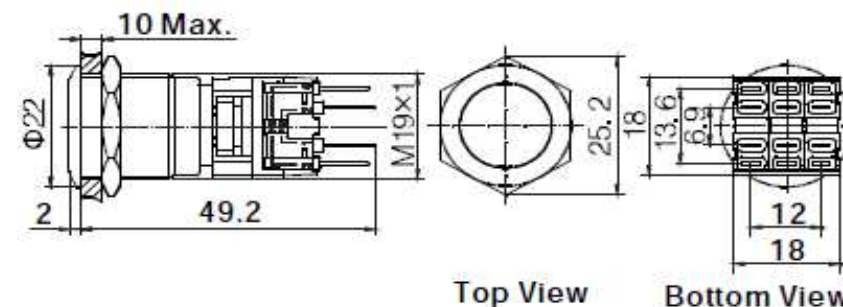

19MM Anti-Vandal-Switch

Part No.: **Q36031**

Customer:

DRW:	Jason	CHKD	Wilson	MATL:	Wilson	TOLERANCE	Mason	DATE	20.08.2009
APPD:	Schumi			FINISH	Jamy		Sheet No.	1 from 3	

EDCON-COMPONENTS

















Visual Effect



Stainless steel (Spiral surface)

Engraving Options

Order Code	 A4	 A3	 A2	 A1
Order Code	 A8	 A7	 A6	 A5
Order Code	 B3	 B2	 B1	 A9
Order Code	 Bx	You can create our own symbol Bx	 B5	 B4

19MM Anti-Vandal-Switch

Part No.: **Q36031**

Customer:

DRW:	Jason	CHKD	Wilson	MATL:	Wilson	TOLERANCE	Mason	DATE	20.08.2009
APPD:	Schumi			FINISH	Jamy		Sheet No.		2 from 3

EDCON-COMPONENTS



Ordering Informations

Serie	Front Shape	Contact Structure	Lamp Type	Connect Type	Lamp Color	Lamp Voltage	Crust Material	Engraving Options	Operating Type	ROHS	Packing Style
-------	-------------	-------------------	-----------	--------------	------------	--------------	----------------	-------------------	----------------	------	---------------

Q36031	F	11	N	3	A	0	S	N	M	R	N
---------------	----------	-----------	----------	----------	----------	----------	----------	----------	----------	----------	----------

F= Flat	11= 1NO1NC	N= no Function	3= Pin Terminal	A= No Function	0= without	S= Stainless Steel	N= no Function	M= Momentary	R= ROHS Conform	N= White Carton
	22= 2NO2NC							A= Alternate	N= NON ROHS Conform	I= Individual Packing
	33= 3NO3NC									

19MM Anti-Vandal-Switch

Part No.: **Q36031**

DRW:	Jason	CHKD	Wilson	MATL:	Wilson	TOLERANCE	Mason	DATE	20.08.2009	Customer:
APPD:	Schumi			FINISH	Jamy		Sheet No.	3 from 3		

www.edcon-components.com

email: info@edcon-components.com