

# EDCON-COMPONENTS



## Specifications

Switch Rating:	Ith=3A Ui=250VAC
Contact Configuration:	1NO!NC / 2NO2NC
Operating Type:	look order code
IP-Degree:	IP40 / IP65
Crust Material:	Stainless Steel
Terminal Type:	Pin Terminal (1,8x0,4mm)
Switching:	Momentary / Alternate
Contact Resistance:	≤ 50mΩ
Insulation Resistance:	≥ 1000MΩ
Dielectric Strength:	2000VAC
Operating Temperature:	. -20°C ~ +55°C
Mechanical Life:	1.000.000 cycles
Electrical Life:	50.000 cycles
Panel Thickness:	1 ~ 10mm
Torque:	5 ~ 14Nm
Operating Pressure:	2,5 ~ 4Nm
Operating Distance:	About 2,8Nm

## Material

Contact:	Silver Alloy
Button:	Stainless Steel / Nickel Plated
Body:	Stainless Steel / Nickel Plated
Base:	PBT
<b>ROHS:</b>	Made to Order-Code

## Drawing

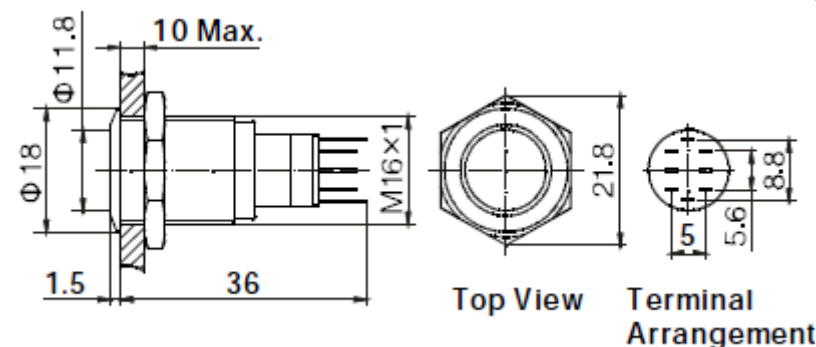

## 16MM Anti-Vandal-Switch

Part No.: **Q36023**

Customer:

DRW:	Jason	CHKD	Wilson	MATL:	Wilson	TOLERANCE	Mason	DATE	20.08.2009
APPD:	Schumi			FINISH	Jamy		Sheet No.	1 from 3	

# EDCON-COMPONENTS



## Visual Effect of Surface



Nickel - plated brass  
(Satin surface)



Stainless steel (Spiral surface)



Gold - plated brass (Satin surface)

## Engraving Options

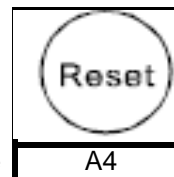

Order Code

A4

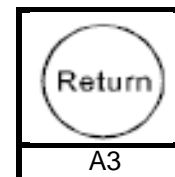

A3

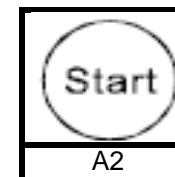

A2

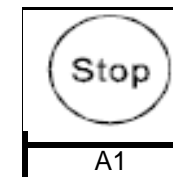

A1

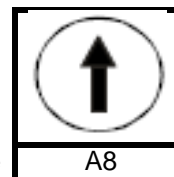

Order Code

A8

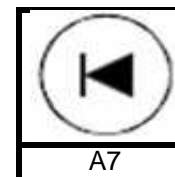

A7

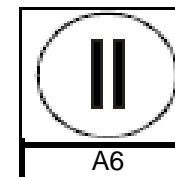

A6

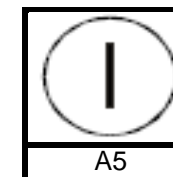

A5

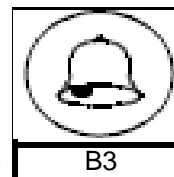

Order Code

B3

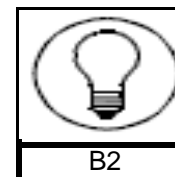

B2

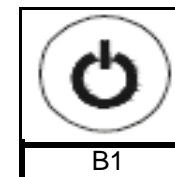

B1

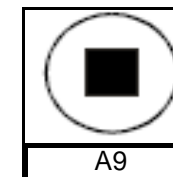

A9

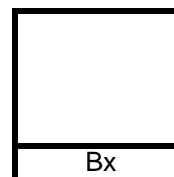

Order Code

Bx

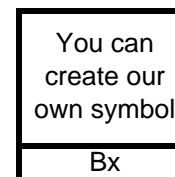

Bx

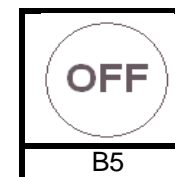

B5

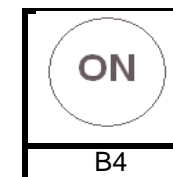

B4

**16MM Anti-Vandal-Switch**

Part No.: **Q36023**

DRW:	Jason	CHKD	Wilson	MATL:	Wilson	TOLERANCE	Mason	DATE	20.08.2009	Customer:
APPD:	Schumi			FINISH	Jamy		Sheet No.	2 from 3		

# EDCON-COMPONENTS



## Ordering Informations

Serie	Front Shape	Contact Structure	Lamp Type	Connect Type	Knob Color	Lamp Voltage	Crust Material	Engraving Options	ROHS	Packing Style
-------	-------------	-------------------	-----------	--------------	------------	--------------	----------------	-------------------	------	---------------

<b>Q36023</b>	<b>F</b>	<b>11</b>	<b>N</b>	<b>3</b>	<b>A</b>	<b>0</b>	<b>S</b>	<b>A1</b>	<b>R</b>	<b>N</b>
---------------	----------	-----------	----------	----------	----------	----------	----------	-----------	----------	----------

<b>F= Flat</b>	<b>11= 1NO1NC</b> <b>22= 2NO2NC</b>	<b>N= no Function</b>	<b>3= Pin Terminal</b>	<b>A= No Function</b>	<b>0= without</b>	<b>S= Stainless Steel</b> <b>N= Nickel Plated Brass</b>	<b>XX= Look Order Code Engraving Options</b>	<b>R= ROHS Conform</b> <b>N= NON ROHS Conform</b>	<b>N= White Carton</b> <b>I= Individual Packing</b>
----------------	--	-----------------------	------------------------	-----------------------	-------------------	--	--	--	--

**16MM Anti-Vandal-Switch**

Part No.: **Q36023**

DRW:	Jason	CHKD	Wilson	MATL:	Wilson	TOLERANCE	Mason	DATE	20.08.2009	Customer:
APPD:	Schumi			FINISH	Jamy		Sheet No.	3 from 3		

[www.edcon-components.com](http://www.edcon-components.com)

email: [info@edcon-components.com](mailto:info@edcon-components.com)