

# EDCON-COMPONENTS



## Specifications

Switch Rating:	2A/36VDC
Contact Configuration:	1NO
Operating Type:	Momentary 1NO (1NC Made by Order)
IP-Degree:	IP65
Crust Material:	Stainless Steel
Terminal Type:	Screw Terminal
Switching:	ON ( Momentary)
Contact Resistance:	≤ 50mΩ
Insulation Resistance:	≥ 1000MΩ
Dielectric Strength:	2000VAC
Operating Temperature:	. -20°C ~ +55°C
Mechanical Life:	1.000.000 cycles
Electrical Life:	200.000 cycles
Panel Thickness:	1 ~ 10mm
Torque:	5 ~ 14Nm
Operating Pressure:	About 4N
Operating Distance:	About 1,8Nm

## Material

Contact:	Silver Alloy
Button:	Stainless Steel / Nickel Plated / Gold-Plated
Body:	Stainless Steel / Nickel Plated / Gold-Plated
Base:	PBT
<b>ROHS:</b>	Made to Order-Code

## Drawing

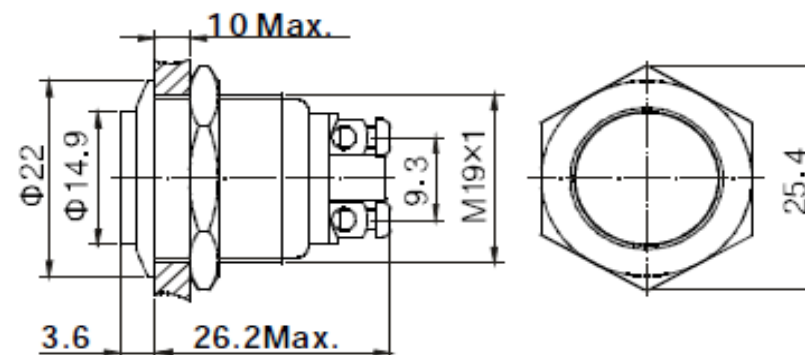

## 19MM Anti-Vandal-Switch

Part No.: **Q36019**

Customer:

DRW:	Jason	CHKD	Wilson	MATL:	Wilson	TOLERANCE	Mason	DATE	20.08.2009
APPD:	Schumi			FINISH	Jamy		Sheet No.	1 from 3	

# EDCON-COMPONENTS



## Visual Effect of Surface



Nickel - plated brass  
(Satin surface)



Stainless steel (Spiral surface)



Gold - plated brass (Satin surface)

## Engraving Options

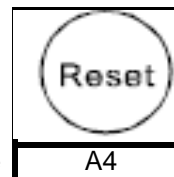

Order Code

A4

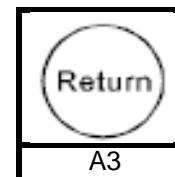

A3

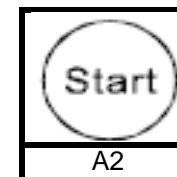

A2

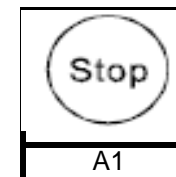

A1

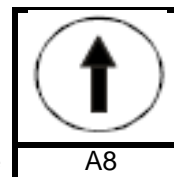

Order Code

A8

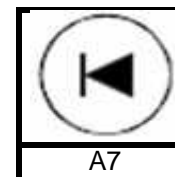

A7

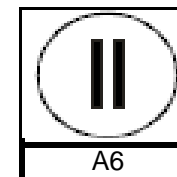

A6

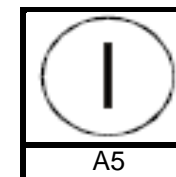

A5

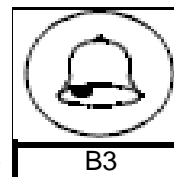

Order Code

B3

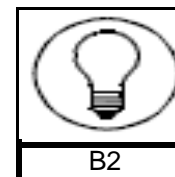

B2

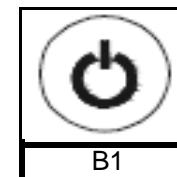

B1

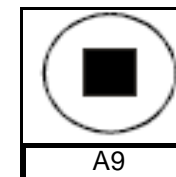

A9

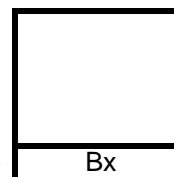

Order Code

Bx

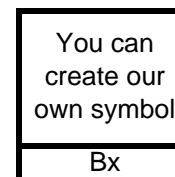

Bx

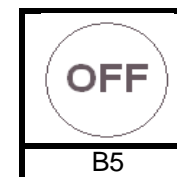

B5

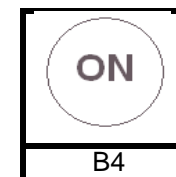

B4

### 19MM Anti-Vandal-Switch

Part No.: **Q36019**

Customer:

DRW:	Jason	CHKD	Wilson	MATL:	Wilson	TOLERANCE	Mason	DATE	20.08.2009
APPD:	Schumi			FINISH	Jamy		Sheet No.		2 from 3

# EDCON-COMPONENTS



## Ordering Informations

Serie	Front Shape	Contact Structure	Lamp Type	Connect Type	Knob Color	Lamp Voltage	Crust Material	Engraving Options	ROHS	Packing Style
<b>Q36019</b>	<b>H</b>	<b>10</b>	<b>N</b>	<b>2</b>	<b>A</b>	<b>0</b>	<b>S</b>	<b>A1</b>	<b>R</b>	<b>N</b>
	<b>H= High</b>	<b>10= 1NO</b> <b>20= 1NC</b>	<b>N= no Function</b>	<b>2= Screw Terminal</b>	<b>A= No Function</b>	<b>0= without</b>	<b>S= Stainless Steel</b> <b>N= Nickel Plated Brass</b> <b>G= Gold Plated Brass</b>	<b>XX= Look Order Code Engraving Options</b>	<b>R= ROHS Conform</b> <b>N= NON ROHS Conform</b>	<b>N= White Carton</b> <b>I= Individual Packing</b>

**19MM Anti-Vandal-Switch**

Part No.: **Q36019**

DRW:	Jason	CHKD	Wilson	MATL:	Wilson	TOLERANCE	Mason	DATE	20.08.2009	Customer:
APPD:	Schumi			FINISH	Jamy		Sheet No.	3 from 3		