

# EDCON-COMPONENTS



## Specifications

Switch Rating:	2A/36VDC
Contact Configuration:	1NO
Operating Type:	Momentary
IP-Degree:	IP65
Crust Material:	Stainless Steel
Terminal Type:	Solder Lug
Switching:	ON ( Momentary)
Contact Resistance:	≤ 50mΩ
Insulation Resistance:	≥ 1000MΩ
Dielectric Strength:	2000VAC
Operating Temperature:	-20°C ~ +55°C
Mechanical Life:	1.000.000 cycles
Electrical Life:	200.000 cycles
Panel Thickness:	1 ~ 6mm
Torque:	5 ~ 14Nm
Operating Pressure:	About 4N
Operating Distance:	About 1,5Nm

## Drawing

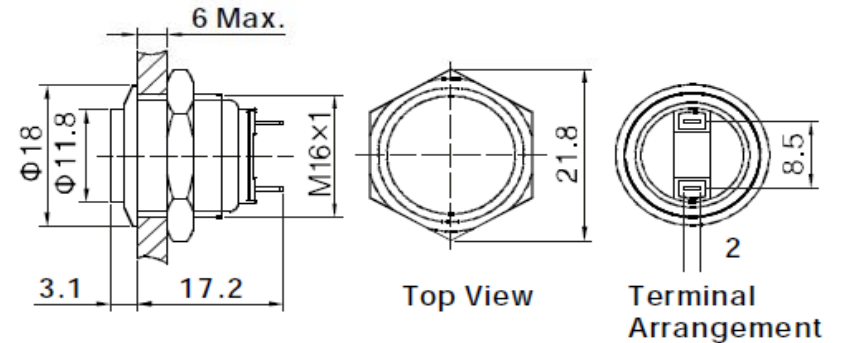

## Material

Contact:	Silver Alloy
Button:	Stainless Steel / Nickel Plated / Gold-Plated
Body:	Stainless Steel / Nickel Plated / Gold-Plated
Base:	PBT
<b>ROHS:</b>	Made to Order-Code

**16MM Anti-Vandal-Switch**

Part No.: **Q36016**

Customer:

DRW:	Jason	CHKD	Wilson	MATL:	Wilson	TOLERANCE	Mason	DATE	01.09.2020
APPD:	Schumi			FINISH	Jamy		Sheet No.		1 from 3

# EDCON-COMPONENTS



## Visual Effect of Surface



Nickel - plated brass  
(Satin surface)





Stainless steel (Spiral surface)

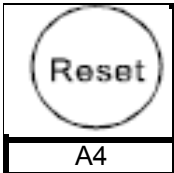
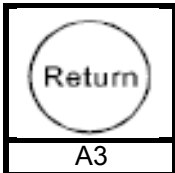
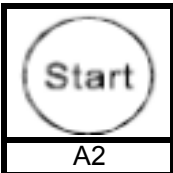
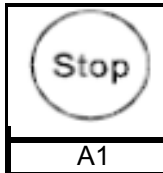
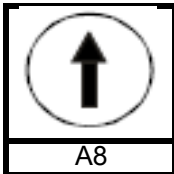
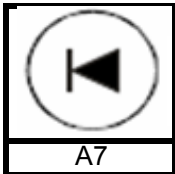
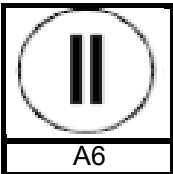
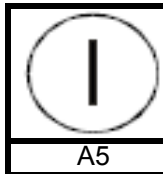
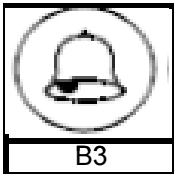
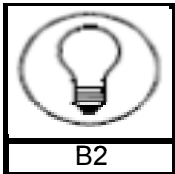
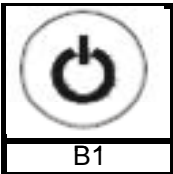
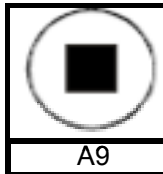
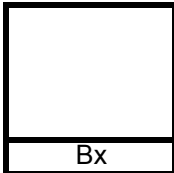

Gold - plated brass (Satin surface)

## Engraving Options

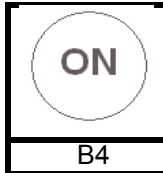
Order Code	 A4	 A3	 A2	 A1
Order Code	 A8	 A7	 A6	 A5
Order Code	 B3	 B2	 B1	 A9
Order Code	 Bx	You can create our own symbol Bx	 B5	 B4

**16MM Anti-Vandal-Switch**

Part No.: **Q36016**

DRW:	Jason	CHKD	Wilson	MATL:	Wilson	TOLERANCE	Mason	DATE	01.09.2020
APPD:	Schumi			FINISH	Jamy		Sheet No.		2 from 3

Customer:

# EDCON-COMPONENTS



## Ordering Informations

Serie	Front Shape	Contact Structure	Lamp Type	Connect Type	Knob Color	Lamp Voltage	Crust Material	Engraving Options	ROHS	Packing Style
<b>Q36016</b>	<b>H</b>	<b>10</b>	<b>N</b>	<b>1</b>	<b>A</b>	<b>0</b>	<b>S</b>	<b>A1</b>	<b>R</b>	<b>N</b>

<b>H=</b> High	<b>10=</b> 1NO	<b>N=</b> no Function	<b>1=</b> Solder Lug	<b>A=</b> No Function	<b>0=</b> without	<b>S=</b> Stainless Steel	<b>XX=</b> Look Order Code Engraving Options	<b>R=</b> ROHS Conform	<b>N=</b> White Carton
						<b>N=</b> Nickel Plated Brass		<b>N=</b> NON ROHS Conform	<b>I=</b> Individual Packing
						<b>G=</b> Gold Plated Brass			

**16MM Anti-Vandal-Switch**

Part No.: **Q36016**

DRW:	Jason	CHKD	Wilson	MATL:	Wilson	TOLERANCE	Mason	DATE	01.09.2020
APPD:	Schumi			FINISH	Jamy		Sheet No.	3 from 3	Customer: