

EDCON-COMPONENTS



Specifications

Switch Rating:	2A/36VDC
Contact Configuration:	1NO
Operating Type:	Momentary
IP-Degree:	IP65
Crust Material:	Stainless Steel
Terminal Type:	Screw Terminal
Switching:	ON (Momentary)
Contact Resistance:	≤ 50mΩ
Insulation Resistance:	≥ 1000MΩ
Dielectric Strength:	2000VAC
Operating Temperature:	. -20°C ~ +55°C
Mechanical Life:	1.000.000 cycles
Electrical Life:	200.000 cycles
Panel Thickness:	1 ~ 6mm
Torque:	5 ~ 14Nm
Operating Pressure:	About 4N
Operating Distance:	About 1,5Nm

Material

Contact:	Silver Alloy
Button:	Stainless Steel / Nickel Plated / Gold-Plated
Body:	Stainless Steel / Nickel Plated / Gold-Plated
Base:	PBT
ROHS:	Made to Order-Code

Drawing

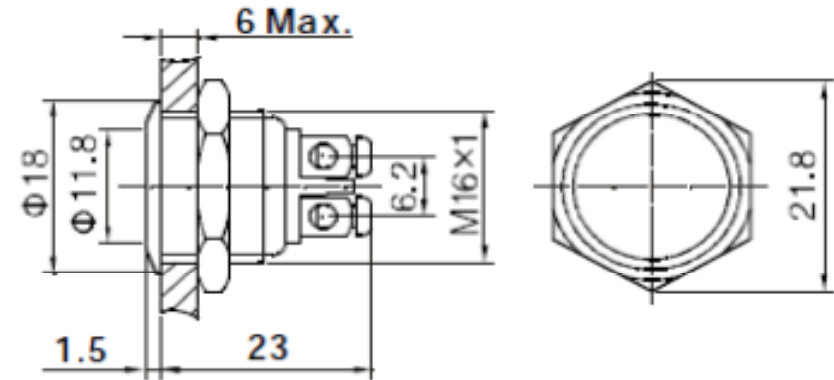

16MM Anti-Vandal-Switch

Part No.: **Q36012-**

Customer:

DRW:	Jason	CHKD	Wilson	MATL:	Wilson	TOLERANCE	Mason	DATE	21.12.2020
APPD:	Schumi			FINISH	Jamy		Sheet No.		1 from 3

www.edcon-components.com

email: info@edcon-components.com

EDCON-COMPONENTS



Visual Effect of Surface



Nickel - plated brass
(Satin surface)





Stainless steel (Spiral surface)

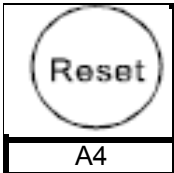
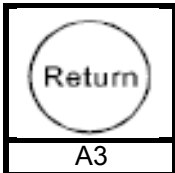
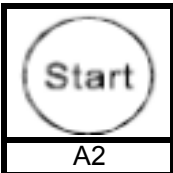
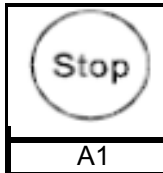
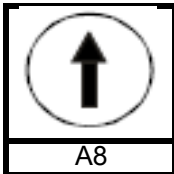
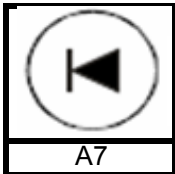
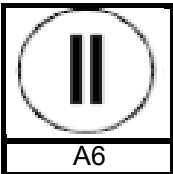
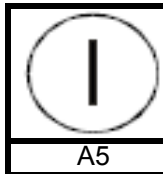
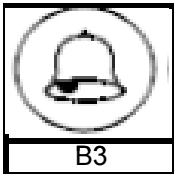
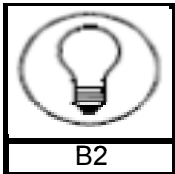
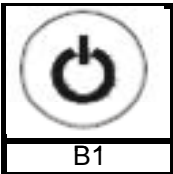
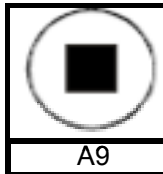
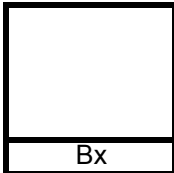

Gold - plated brass (Satin surface)

Engraving Options

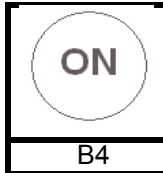
Order Code	 A4	 A3	 A2	 A1
Order Code	 A8	 A7	 A6	 A5
Order Code	 B3	 B2	 B1	 A9
Order Code	 Bx	You can create our own symbol Bx	 B5	 B4

16MM Anti-Vandal-Switch

Part No.: **Q36012-**

DRW:	Jason	CHKD	Wilson	MATL:	Wilson	TOLERANCE	Mason	DATE	21.12.2020
APPD:	Schumi			FINISH	Jamy		Sheet No.		2 from 3

Customer:

EDCON-COMPONENTS



Ordering Informations

Serie	Front Shape	Contact Structure	Lamp Type	Connect Type	Knob Color	Lamp Voltage	Crust Material	Engraving Options	ROHS	Packing Style
Q36012-	F	10	N	1	A	0	S	00	R	N

F= Flat	10= 1NO 20= 1NC	N= no Function	1= Screw	A= No Function	0= without	S= Stainless Steel N= Nickel Plated Brass G= Gold Plated Brass	XX= Look Order Code Engraving Options	R= ROHS Conform N= NON ROHS Conform	N= White Carton I= Individual Packing
----------------	----------------------------------	-----------------------	-----------------	-----------------------	-------------------	---	--	--	--

16MM Anti-Vandal-Switch

Part No.: **Q36012-**

DRW:	Jason	CHKD	Wilson	MATL:	Wilson	TOLERANCE	Mason	DATE	21.12.2020
APPD:	Schumi			FINISH	Jamy		Sheet No.		3 from 3

Customer: