

EDCON-COMPONENTS



Specifications

| | |
|------------------------|------------------|
| Switch Rating: | 2A/36VDC |
| Contact Configuration: | 1NO |
| Operating Type: | Momentary |
| IP-Degree: | IP65 |
| Crust Material: | Stainless Steel |
| Terminal Type: | Screw Terminal |
| Switching: | ON (Momentary) |
| Contact Resistance: | ≤ 50mΩ |
| Insulation Resistance: | ≥ 1000MΩ |
| Dielectric Strength: | 2000VAC |
| Operating Temperature: | . -20°C ~ +55°C |
| Mechanical Life: | 1.000.000 cycles |
| Electrical Life: | 200.000 cycles |
| Panel Thickness: | 1 ~ 6mm |
| Torque: | 5 ~ 14Nm |
| Operating Pressure: | About 4N |
| Operating Distance: | About 1,5Nm |

Material

| | |
|--------------|---|
| Contact: | Silver Alloy |
| Button: | Stainless Steel / Nickel Plated / Gold-Plated |
| Body: | Stainless Steel / Nickel Plated / Gold-Plated |
| Base: | PBT |
| ROHS: | Made to Order-Code |

Drawing

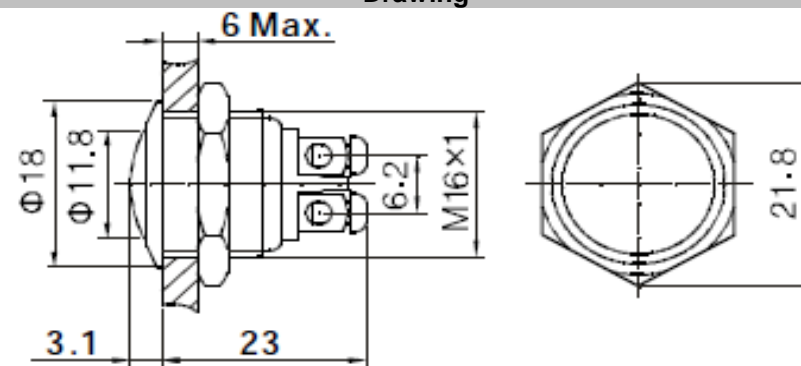

16MM Anti-Vandal-Switch

Part No.: **Q36011**

Customer:

| | | | | | | | | | |
|-------|--------|------|--------|--------|--------|-----------|-----------|----------|------------|
| DRW: | Jason | CHKD | Wilson | MATL: | Wilson | TOLERANCE | Mason | DATE | 20.08.2009 |
| APPD: | Schumi | | | FINISH | Jamy | | Sheet No. | 1 from 3 | |

EDCON-COMPONENTS



Visual Effect of Surface



Nickel - plated brass
(Satin surface)



Stainless steel (Spiral surface)



Gold - plated brass (Satin surface)

Engraving Options

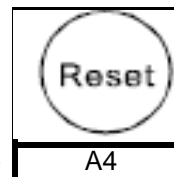

Order Code

A4

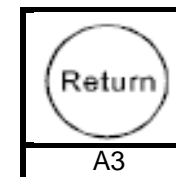

A3

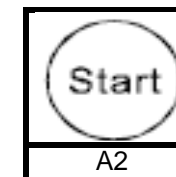

A2

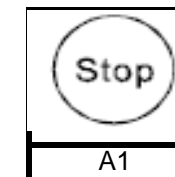

A1

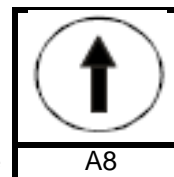

Order Code

A8

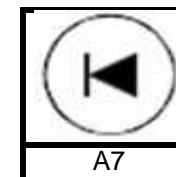

A7

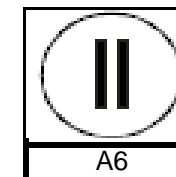

A6

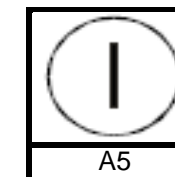

A5

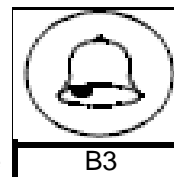

Order Code

B3

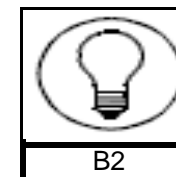

B2

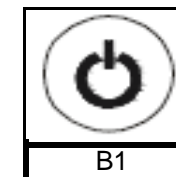

B1

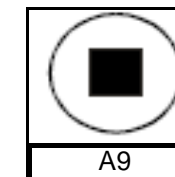

A9

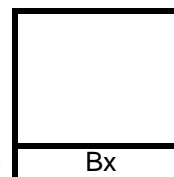

Order Code

Bx

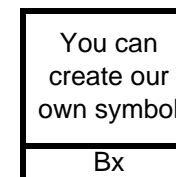

Bx

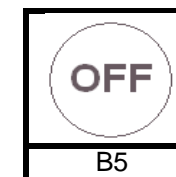

B5

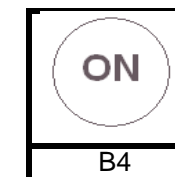

B4

16MM Anti-Vandal-Switch

Part No.: **Q36011**

| | | | | | | | | | | |
|-------|--------|------|--------|--------|--------|-----------|-----------|----------|------------|-----------|
| DRW: | Jason | CHKD | Wilson | MATL: | Wilson | TOLERANCE | Mason | DATE | 20.08.2009 | Customer: |
| APPD: | Schumi | | | FINISH | Jamy | | Sheet No. | 2 from 3 | | |

EDCON-COMPONENTS



Ordering Informations

| Serie | Front Shape | Contact Structure | Lamp Type | Connect Type | Knob Color | Lamp Voltage | Crust Material | Engraving Options | ROHS | Packing Style |
|---------------|-------------|-------------------|-----------|--------------|------------|--------------|----------------|-------------------|----------|---------------|
| Q36011 | B | 10 | N | 1 | A | 0 | S | A1 | R | N |

| | | | | | | | | | |
|-----------------|----------------------------------|-----------------------|----------------------|-----------------------|-------------------|---|--|--|--|
| B= Domed | 10= 1NO 20= 1NC | N= no Function | 1= Solder Lug | A= No Function | 0= without | S= Stainless Steel N= Nickel Plated Brass G= Gold Plated Brass | XX= Look Order Code Engraving Options | R= ROHS Conform N= NON ROHS Conform | N= White Carton I= Individual Packing |
|-----------------|----------------------------------|-----------------------|----------------------|-----------------------|-------------------|---|--|--|--|

16MM Anti-Vandal-Switch

Part No.: **Q36011**

| | | | | | | | | | | |
|-------|--------|------|--------|--------|--------|-----------|-----------|----------|------------|-----------|
| DRW: | Jason | CHKD | Wilson | MATL: | Wilson | TOLERANCE | Mason | DATE | 20.08.2009 | Customer: |
| APPD: | Schumi | | | FINISH | Jamy | | Sheet No. | 3 from 3 | | |