

EDCON-COMPONENTS



Specifications

Switch Rating:	3A/250VAC
Contact Configuration:	1NO1NC/2NO2NC
Operating Type:	LOOK-Type
IP-Degree:	IP40/65
Crust Material:	Stainless Steel / Nickel Plated Brass
Terminal Type:	Solder Lug (1,8x0,4mm)
Switching:	ON / OFF
Contact Resistance:	≤ 50mΩ
Insulation Resistance:	≥ 1000MΩ
Dielectric Strength:	2000VAC
Operating Temperature:	. -20°C ~ +55°C
Mechanical Life:	1.000.000 cycles
Electrical Life:	50.000 cycles
Panel Thickness:	1 ~ 10mm
Torque:	5 ~ 14Nm
Operating Pressure:	About 2,5 ~ 4N
Operating Distance:	About 2,8Nm

Material

Contact:	Silver Alloy														
Button:	Stainless Steel / Nickel Plated														
Body:	Stainless Steel / Nickel Plated														
Base:	PBT														
ROHS:	Made to Order-Code														
Type:	Illuminated (LED)														
Color:	<table border="0" style="display: inline-table; vertical-align: middle;"> <tr> <td style="background-color: red; color: white; padding: 2px;">R</td> <td style="background-color: yellow; color: black; padding: 2px;">Y</td> <td style="background-color: orange; color: white; padding: 2px;">O</td> <td style="padding: 0 10px;"> </td> <td style="background-color: green; color: white; padding: 2px;">G</td> <td style="background-color: cyan; color: white; padding: 2px;">B</td> <td style="background-color: grey; color: white; padding: 2px;">W</td> </tr> <tr> <td colspan="3">AC/DC 1,7V</td> <td></td> <td colspan="3">AC/DC 2,8V</td> </tr> </table>	R	Y	O		G	B	W	AC/DC 1,7V				AC/DC 2,8V		
R	Y	O		G	B	W									
AC/DC 1,7V				AC/DC 2,8V											
Rated Voltage:	AC/DC 1,7V														
Rated Current:	20mA														
Lifetime:	40000Hrs														

Drawing

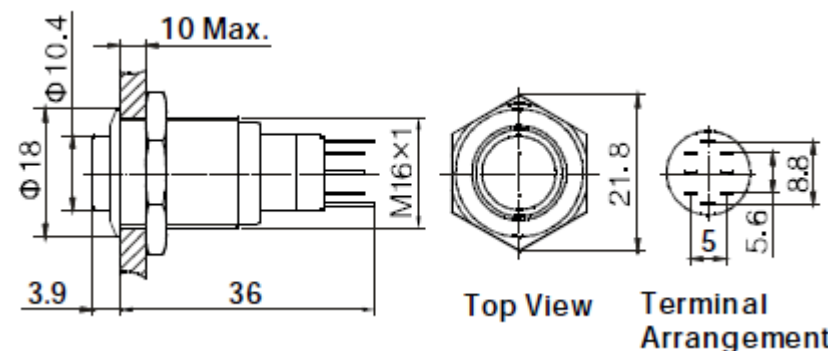

Current Limiting Resistance Configuration Table

Operating Voltage (U)	6V	12V	24V	36V
R Y O	210Ω, 1/4W	510Ω, 1/4W	1,2KΩ, 1/4W	2,2KΩ, 1/4W
G B W	160Ω, 1/4W	470Ω, 1/4W	1,2KΩ, 1/4W	2,2KΩ, 1/4W

Formula	
R=	$\frac{U - U_e}{I_e}$

16MM Anti-Vandal-Switch

Part No.: **Q35023**

DRW:	Jason	CHKD	Wilson	MATL:	Wilson	TOLERANCE	Mason	DATE	14.03.2016	Customer:
APPD:	Schumi			FINISH	Jamy		Sheet No.	1 from 3		

EDCON-COMPONENTS



Visual Effect of Surface

















Nickel - plated brass
(Satin surface)



Stainless steel (Spiral surface)



Gold - plated brass (Satin surface)

Order Code	 A4	 A3	 A2	 A1
Order Code	 A8	 A7	 A6	 A5
Order Code	 B3	 B2	 B1	 A9
Order Code	 Bx	You can create our own symbol Bx	 B5	 B4

16MM Anti-Vandal-Switch

Part No.: **Q35023**

Customer:

DRW:	Jason	CHKD	Wilson	MATL:	Wilson	TOLERANCE	Mason	DATE	14.03.2016
APPD:	Schumi			FINISH	Jamy		Sheet No.		2 from 3

EDCON-COMPONENTS



Ordering Informations

Serie	Front Shape	Contact Structure	Lamp Type	Connect Type	Lamp Color	Lamp Voltage	Crust Material	Engraving Options	ROHS	Packing Style
Q35023	H	10	R	1	A	0	S	00	R	N

H= High	11= 1NO1NC Momentary	R= RING-Size	1= Solder Lug	A= No Function	0= with 0R Resistor before LED	S= Stainless Steel	00= No function	R= ROHS Conform	N= White Carton
	22= 2NO2NC Momentary			R= Red		N= Nickel Plated Brass		N= NON ROHS Conform	I= Individual Packing
	33= 1NO1NC Latching function			G= Green	1= 6V AC/DC	G= Gold Plated Brass			
	44= 2NO2NC Latching function			Y= Yellow	2= 12V AC/DC				
				O= Orange	3= 24V AC/DC				
				B= Blue	4= 36V AC/DC				
				W= White	X= can we make by order				
				P= Dual LED Red/Green	Y= Dual LED Green/Blue				
				Z= Dual LED Red/Blue					

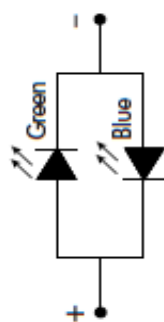
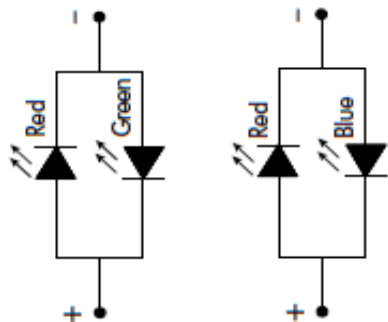

16MM Anti-Vandal-Switch

Part No.: **Q35023**

DRW:	Jason	CHKD	Wilson	MATL:	Wilson	TOLERANCE	Mason	DATE	14.03.2016	Customer:
APPD:	Schumi			FINISH	Jamy		Sheet No.	3 from 3		

www.edcon-components.com

email: info@edcon-components.com