

# EDCON-COMPONENTS



## Specifications

Switch Rating:	5A/250VAC
Contact Configuration:	1NO1NC / 2NO2NC
Operating Type:	Momentary
IP-Degree:	IP65
Crust Material:	Stainless Steel
Terminal Type:	Solder Lug (2,8x0,5mm)
Switching:	ON / OFF
Contact Resistance:	≤ 50mΩ
Insulation Resistance:	≥ 1000MΩ
Dielectric Strength:	2000VAC
Operating Temperature:	.-20°C ~ +55°C
Mechanical Life:	1.000.000 cycles
Electrical Life:	50.000 cycles
Panel Thickness:	1 ~ 10mm
Torque:	5 ~ 14Nm
Operating Pressure:	About 5,5-7Nm
Operating Distance:	About 2,8mm

## Material

Contact:	Silver Alloy												
Button:	Stainless Steel												
Body:	Stainless Steel												
Base:	PA												
ROHS:	Made to Order-Code												
Type:	Illuminated (LED)												
Color:	<table border="0"> <tr> <td><b>R</b></td> <td><b>Y</b></td> <td><b>O</b></td> <td><b>G</b></td> <td><b>B</b></td> <td><b>W</b></td> </tr> <tr> <td>AC/DC 1,7V</td> <td></td> <td></td> <td>AC/DC 2,8V</td> <td></td> <td></td> </tr> </table>	<b>R</b>	<b>Y</b>	<b>O</b>	<b>G</b>	<b>B</b>	<b>W</b>	AC/DC 1,7V			AC/DC 2,8V		
<b>R</b>	<b>Y</b>	<b>O</b>	<b>G</b>	<b>B</b>	<b>W</b>								
AC/DC 1,7V			AC/DC 2,8V										
Rated Voltage:	AC/DC 1,7V												
Rated Current:	20mA												
Lifetime:	40000Hrs												

## Drawing

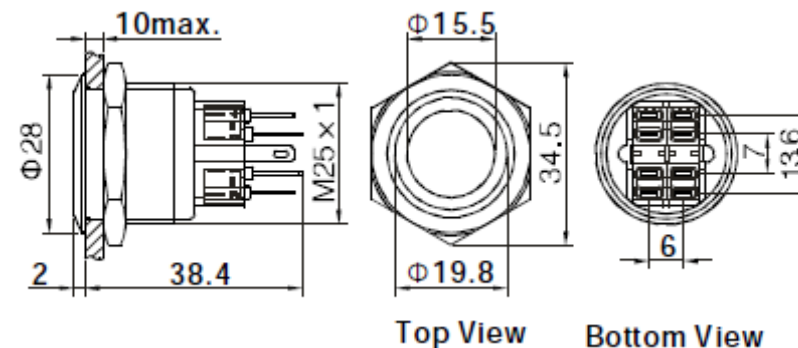

Current Limiting Resistance Configuration Table

Operating Voltage (U)	6V	12V	24V	36V
<b>R</b> <b>Y</b> <b>O</b>	210Ω, 1/4W	510Ω, 1/4W	1,2KΩ, 1/4W	2,2KΩ, 1/4W
<b>G</b> <b>B</b> <b>W</b>	160Ω, 1/4W	470Ω, 1/4W	1,2KΩ, 1/4W	2,2KΩ, 1/4W

Formula	
R=	$\frac{U - U_e}{I_e}$

**25MM Anti-Vandal-Switch**  
Part No.: **Q35019**

DRW:	Jason	CHKD	Wilson	MATL:	Wilson	TOLERANCE	Mason	DATE	14.03.2017	Customer:
APPD:	Schumi			FINISH	Jamy		Sheet No.	1 from 3		

# EDCON-COMPONENTS



## Visual Effect of Surface

















Nickel - plated brass  
(Satin surface)



Stainless steel (Spiral surface)



Gold - plated brass (Satin surface)

Order Code	 A4	 A3	 A2	 A1
Order Code	 A8	 A7	 A6	 A5
Order Code	 B3	 B2	 B1	 A9
Order Code	 Bx	You can create our own symbol Bx	 B5	 B4

**25MM Anti-Vandal-Switch**

Part No.: **Q35019**

DRW:	Jason	CHKD	Wilson	MATL:	Wilson	TOLERANCE	Mason	DATE	14.03.2017	Customer:
APPD:	Schumi			FINISH	Jamy		Sheet No.	2 from 3		

# EDCON-COMPONENTS



## Ordering Informations

Serie	Front Shape	Contact Structure	Lamp Type	Connect Type	Lamp Color	Lamp Voltage	Crust Material	Engraving Options	ROHS	Packing Style
<b>Q35019</b>	<b>F</b>	<b>10</b>	<b>R</b>	<b>3</b>	<b>A</b>	<b>0</b>	<b>S</b>	<b>00</b>	<b>R</b>	<b>N</b>

<b>F= Flat</b>	<b>11= 1NO1NC Momentary</b>	<b>R= RING-Size</b>	<b>3= Pin Terminal</b>	<b>A= No Function</b>	<b>0= with 0R Resistor before LED</b>	<b>S= Stainless Steel</b>	<b>00= No function</b>	<b>R= ROHS Conform</b>	<b>N= White Carton</b>
	<b>22= 2NO2NC Momentary</b>			<b>R= Red</b>		<b>N= Nickel Plated Brass</b>		<b>N= NON ROHS Conform</b>	<b>I= Individual Packing</b>
	<b>33= 1NO1NC Latching function</b>			<b>G= Green</b>	<b>1= 6V AC/DC</b>	<b>G= Gold Plated Brass</b>			
	<b>44= 2NO2NC Latching function</b>			<b>Y= Yellow</b>	<b>2= 12V AC/DC</b>	<b>K= Zn-Alloy (colorized Button Black)</b>			
				<b>O= Orange</b>	<b>3= 24V AC/DC</b>	<b>B= Zn-Alloy (colorized Button Bronze)</b>			
				<b>B= Blue</b>	<b>4= 36V AC/DC</b>				
				<b>W= White</b>	<b>5= 48V AC/DC</b>				
				<b>P= Dual LED Red/Green</b>	<b>6= 110V AC/DC</b>				
				<b>Z= Dual LED Red/Blue</b>	<b>7= 230V AC/DC</b>				
				<b>Y= Dual LED Green/Blue</b>	<b>X= can we make by order</b>				
				<b>T= RGB-LED Tripple Colour</b>					

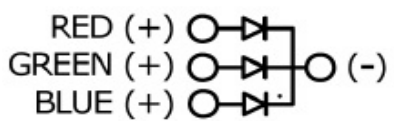
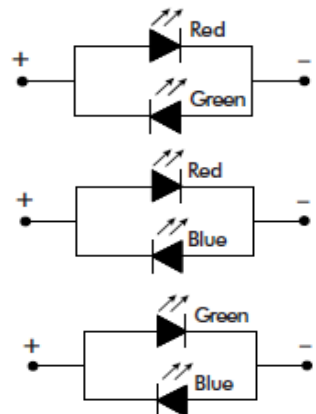

**25MM Anti-Vandal-Switch**  
Part No.: **Q35019**

DRW:	Jason	CHKD	Wilson	MATL:	Wilson	TOLERANCE	Mason	DATE	14.03.2017	Customer:
APPD:	Schumi			FINISH	Jamy		Sheet No.	3 from 3		