

EDCON-COMPONENTS



Specifications

Switch Rating:	5A/250VAC
Contact Configuration:	1NO1NC
Operating Type:	Momentary / Alternate
IP-Degree:	IP65
Crust Material:	Stainless Steel
Terminal Type:	Solder Lug (2,8x0,5mm)
Switching:	ON / OFF
Contact Resistance:	≤ 50mΩ
Insulation Resistance:	≥ 1000MΩ
Dielectric Strength:	2000VAC
Operating Temperature:	.-20°C ~ +55°C
Mechanical Life:	1.000.000 cycles
Electrical Life:	50.000 cycles
Panel Thickness:	1 ~ 8mm
Torque:	5 ~ 14Nm
Operating Pressure:	About 5,5Nm
Operating Distance:	About 2,5mm

Material

Contact:	Silver Alloy												
Button:	Stainless Steel												
Body:	Stainless Steel												
Base:	PA												
ROHS:	Made to Order-Code												
Type:	Illuminated (LED)												
Color:	<table border="0"> <tr> <td>R</td> <td>Y</td> <td>O</td> <td>G</td> <td>B</td> <td>W</td> </tr> <tr> <td></td> <td></td> <td></td> <td>AC/DC 1,7V</td> <td>AC/DC 2,8V</td> <td></td> </tr> </table>	R	Y	O	G	B	W				AC/DC 1,7V	AC/DC 2,8V	
R	Y	O	G	B	W								
			AC/DC 1,7V	AC/DC 2,8V									
Rated Voltage:	AC/DC 1,7V												
Rated Current:	20mA												
Lifetime:	40000Hrs												

Drawing

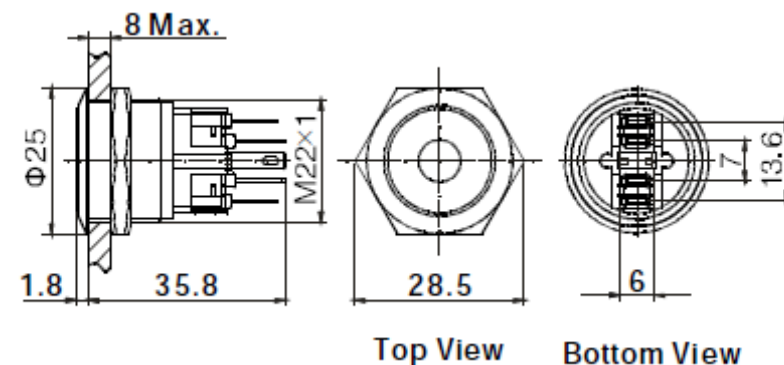

Current Limiting Resistance Configuration Table

Operating Voltage (U)	6V	12V	24V	36V
R Y O	210Ω, 1/4W	510Ω, 1/4W	1,2KΩ, 1/4W	2,2KΩ, 1/4W
G B W	160Ω, 1/4W	470Ω, 1/4W	1,2KΩ, 1/4W	2,2KΩ, 1/4W

Formula	
R=	$\frac{U - U_e}{I_e}$

22MM Anti-Vandal-Switch

Part No.: **Q35016**

DRW:	Jason	CHKD	Wilson	MATL:	Wilson	TOLERANCE	Mason	DATE	14.03.2017	Customer:
APPD:	Schumi			FINISH	Jamy		Sheet No.	1 from 3		

EDCON-COMPONENTS



Visual Effect of Surface

















Nickel - plated brass
(Satin surface)



Stainless steel (Spiral surface)



Gold - plated brass (Satin surface)

Order Code	 A4	 A3	 A2	 A1
Order Code	 A8	 A7	 A6	 A5
Order Code	 B3	 B2	 B1	 A9
Order Code	 Bx	You can create our own symbol Bx	 B5	 B4

22MM Anti-Vandal-Switch

Part No.: **Q35016**

DRW:	Jason	CHKD	Wilson	MATL:	Wilson	TOLERANCE	Mason	DATE	14.03.2017	Customer:
APPD:	Schumi			FINISH	Jamy		Sheet No.		2 from 3	

EDCON-COMPONENTS



Ordering Informations

Serie	Front Shape	Contact Structure	Lamp Type	Connect Type	Lamp Color	Lamp Voltage	Crust Material	Engraving Options	ROHS	Packing Style
Q35016	F	10	D	3	A	0	S	00	R	N

F= Flat	11= 1NO1NC Momentary	D= DOT-Size	3= Pin Terminal	A= No Function	0= with 0R Resistor before LED	S= Stainless Steel	00= No function	R= ROHS Conform	N= White Carton
	22= 2NO2NC Momentary			R= Red					
	33= 1NO1NC Latching function			G= Green	2= 12V AC/DC	G= Gold Plated Brass			
	44= 2NO2NC Latching function			Y= Yellow	O= Orange		K= Zn-Alloy (colorized Button Black)		
		B= Blue	3= 24V AC/DC	B= Zn-Alloy (colorized Button Bronze)					
		W= White	4= 36V AC/DC						
		P= Dual LED Red/Green	5= 48V AC/DC						
		Z= Dual LED Red/Blue	6= 110V AC/DC						
		Y= Dual LED Green/Blue	7= 230V AC/DC						
		T= RGB-LED Tripple Colour	X= can we make by order						

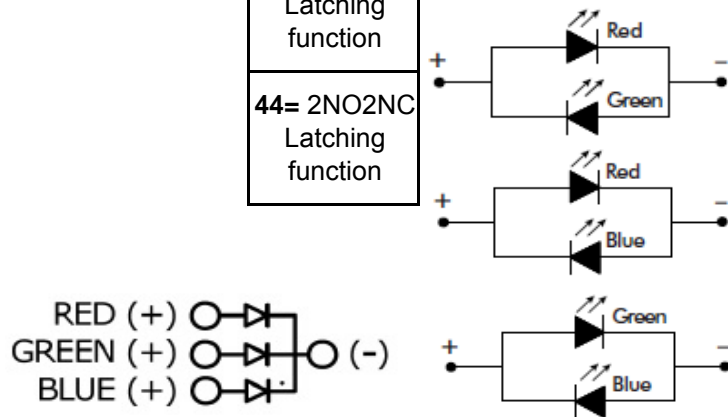

22MM Anti-Vandal-Switch	
Part No.:	Q35016
Customer:	

DRW:	Jason	CHKD	Wilson	MATL:	Wilson	TOLERANCE	Mason	DATE	14.03.2017
APPD:	Schumi			FINISH	Jamy		Sheet No.		3 from 3