

EDCON-COMPONENTS



Specifications

Switch Rating:	2A/36VDC
Contact Configuration:	1NO
Operating Type:	Momentary 1NO
IP-Degree:	IP65
Crust Material:	Stainless Steel / Nickel Plated Brass
Terminal Type:	Solder Lug
Switching:	ON (Momentary)
Contact Resistance:	≤ 50mΩ
Insulation Resistance:	≥ 1000MΩ
Dielectric Strength:	2000VAC
Operating Temperature:	. -20°C ~ +55°C
Mechanical Life:	1.000.000 cycles
Electrical Life:	50.000 cycles
Panel Thickness:	1 ~ 10mm
Torque:	5 ~ 14Nm
Operating Pressure:	About 4N
Operating Distance:	About 1,5Nm

Material

Contact:	Silver Alloy														
Button:	Stainless Steel / Nickel Plated														
Body:	Stainless Steel / Nickel Plated														
Base:	PBT														
ROHS:	Made to Order-Code														
Type:	Illuminated (LED)														
Color:	<table border="0" style="display: inline-table;"> <tr> <td style="background-color: red; color: white; padding: 2px;">R</td> <td style="background-color: yellow; color: black; padding: 2px;">Y</td> <td style="background-color: orange; color: white; padding: 2px;">O</td> <td style="padding: 0 10px;"> </td> <td style="background-color: green; color: white; padding: 2px;">G</td> <td style="background-color: cyan; color: white; padding: 2px;">B</td> <td style="background-color: grey; color: white; padding: 2px;">W</td> </tr> <tr> <td colspan="3">AC/DC 1,7V</td> <td></td> <td colspan="3">AC/DC 2,8V</td> </tr> </table>	R	Y	O		G	B	W	AC/DC 1,7V				AC/DC 2,8V		
R	Y	O		G	B	W									
AC/DC 1,7V				AC/DC 2,8V											
Rated Voltage:	AC/DC 1,7V														
Rated Current:	20mA														
Lifetime:	40000Hrs														

Drawing

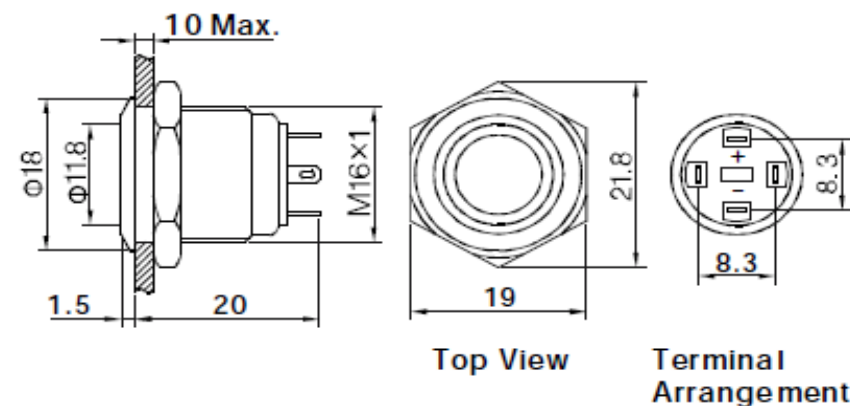

Current Limiting Resistance Configuration Table

Operating Voltage (U)	6V	12V	24V	36V
R Y O	210Ω, 1/4W	510Ω, 1/4W	1,2KΩ, 1/4W	2,2KΩ, 1/4W
G B W	160Ω, 1/4W	470Ω, 1/4W	1,2KΩ, 1/4W	2,2KΩ, 1/4W

Formula	
R=	$\frac{U - U_e}{I_e}$

16MM Anti-Vandal-Switch

Part No.: **Q35004**

DRW:	Jason	CHKD	Wilson	MATL:	Wilson	TOLERANCE	Mason	DATE	14.03.2016
APPD:	Schumi			FINISH	Jamy		Sheet No.	1 from 3	Customer:

EDCON-COMPONENTS



Visual Effect of Surface

















Nickel - plated brass
(Satin surface)



Stainless steel (Spiral surface)



Gold - plated brass (Satin surface)

Order Code	 A4	 A3	 A2	 A1
Order Code	 A8	 A7	 A6	 A5
Order Code	 B3	 B2	 B1	 A9
Order Code	 Bx	You can create our own symbol Bx	 B5	 B4

16MM Anti-Vandal-Switch	
Part No.:	Q35004
Customer:	

DRW:	Jason	CHKD	Wilson	MATL:	Wilson	TOLERANCE	Mason	DATE	14.03.2016
APPD:	Schumi			FINISH	Jamy		Sheet No.		2 from 3

EDCON-COMPONENTS



Ordering Informations

Serie	Front Shape	Contact Structure	Lamp Type	Connect Type	Lamp Color	Lamp Voltage	Crust Material	Engraving Options	ROHS	Packing Style
Q35004	F	10	R	1	A	0	S	00	R	N

F= Flat	11= 1NO1NC Momentary	R= RING-Size	1= Solder Lug	A= No Function	0= with 0R Resistor before LED	S= Stainless Steel	00= No function	R= ROHS Conform	N= White Carton			
	22= 2NO2NC Momentary			R= Red						1= 6V AC/DC	N= Nickel Plated Brass	
	33= 1NO1NC Latching function			G= Green								2= 12V AC/DC
	44= 2NO2NC Latching function			Y= Yellow								
			O= Orange	4= 36V AC/DC	G= Gold Plated Brass							
			B= Blue			X= can we make by order						
			W= White	Y= Dual LED Green/Blue								
			P= Dual LED Red/Green									
			Z= Dual LED Red/Blue									

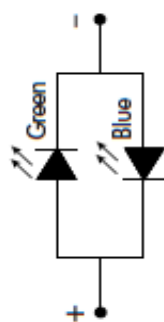
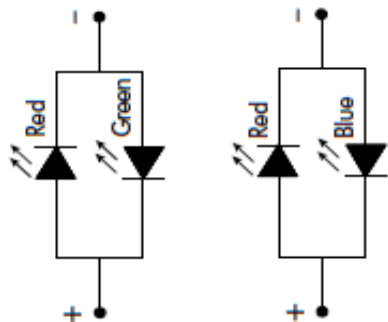

16MM Anti-Vandal-Switch

Part No.: **Q35004**

DRW:	Jason	CHKD	Wilson	MATL:	Wilson	TOLERANCE	Mason	DATE	14.03.2016	Customer:
APPD:	Schumi			FINISH	Jamy		Sheet No.	3 from 3		

www.edcon-components.com

email: info@edcon-components.com