



## DISCRIPTION

### FEATURES

Low profile very effective in space-conscious applications.  
Low resistance and high energy storage.

### OPTIONS

Tape & Reel is Standard  
Tolerance: M=20% is Standard,  
Tighter Tolerances Available

### APPLICATIONS

Excellent as DC-DC Converter used in notebooks computers, PDA and mobile hand-phones.  
Step-down converters, flash memory.

## PHYSICAL CHARACTERISTICS

- Inductance measured by LCR Meter HP 4284A
- DC Resistance measured by Milliohm meter HP4338B
- SRF measured by Network analyzer HP 4294/HP4291
- SRF is for reference only
- Temperature rise = 40°C max at I rms
- $\Delta L/L0A=10\%$  typical at I sat

## ELECTRICAL SPECIFICATIONS

Properties	Test conditions		Value	Unit	Tol.
Inductance		<b>L</b>	150	$\mu$ H	see Site 2
Q factor		<b>Q</b>	---		min.
DC-resistance		<b>DCR typ.</b>	---	$\Omega$	typ.
DC-resistance		<b>DCR max.</b>	0,25	$\Omega$	max.
Self-Res. Freq.		<b>SRF</b>	4,5	MHz	min.
Test-Freq.			100	KHz	
Rated Current		<b>Irms</b>	1,5	A	max.
Saturation Current		<b>Isat</b>	2,6	A	max.

1. This electronic component is meant to be used in general electronic equipment. Before the incorporation of this component into any equipment with higher and more reliable requirements such as aviation, aerospace, submarine, nuclear control, transportation, transportation signal, disaster prevention, medical, public information network, etc. or if there is a possibility of injuries or damages to the human body, Edcon -Components must be informed before the stage of design-in. Evaluation checks for safety have to be performed on each electronic components used in electrical circuits that require high safety and reliability functions.

### SMT UNSHIELDED POWER INDUCTORS

Part No.: **S41005-151**

Customer:

DRW:	Chang	CHKD	Young	MATL:	Chu Chi	DATE	26.06.2009
APPD:	Pong			FINISH	Vienna	Sheet	1 from 2



## TECHNICAL INFORMATIONS

### Dimensions ( mm )

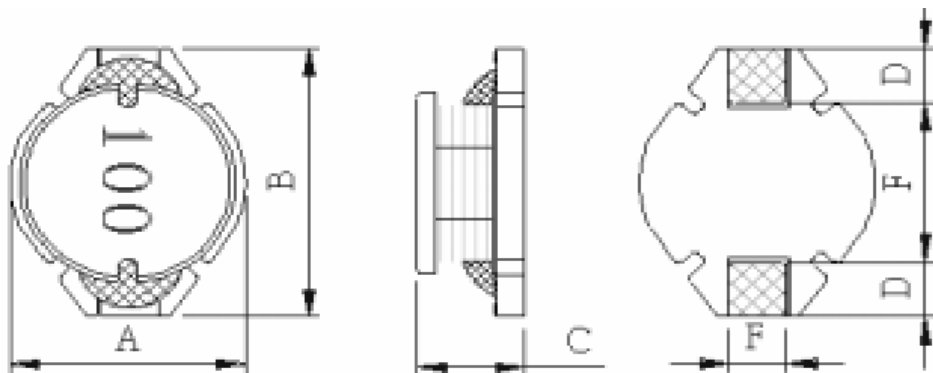

<b>A</b>	15,00 ± 0,2	<b>C</b>	7,00 ± 0,3	<b>E</b>	2,20 ± 0,2
<b>B</b>	18,40 ± 0,2	<b>D</b>	2,40 ± 0,2	<b>F</b>	13,30 ± 0,3

### Ordering Information

Serie and Range	Tolerance	ROHS	Packing
S41005-151	M	R	TR
	K = 10%	R = ROHS	BU = Bulk Ware
	M = 20%	N = non ROHS	TR = Tape Reel

### Soldering Profile for Lead Free Soldering 255-260°C



### Soldering Profile for Lead Free Soldering 235-240°C

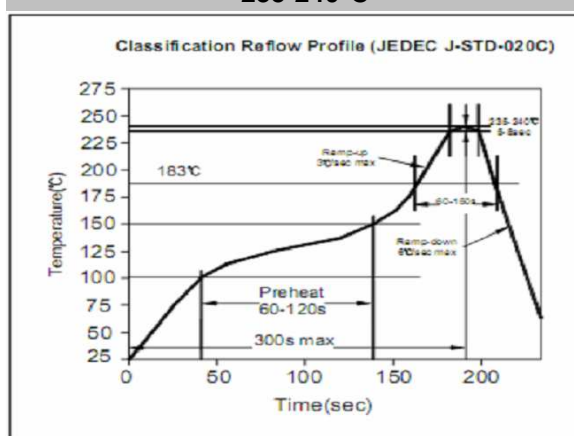

1. This electronic component is meant to be used in general electronic equipment. Before the incorporation of this component into any equipment with higher and more reliable requirements such as aviation, aerospace, submarine, nuclear control, transportation, transportation signal, disaster prevention, medical, public information network, etc. or if there is a possibility of injuries or damages to the human body, Edcon -Components must be informed before the stage of design-in. Evaluation checks for safety have to be performed on each electronic components used in electrical circuits that require high safety and reliability functions.

### SMT UNSHIELDED POWER INDUCTORS

Part No.: **S41005-151**

Customer:

DRW:	Chang	CHKD	Young	MATL:	Chu Chi	DATE	26.06.2009
APPD:	Pong			FINISH	Vienna	Sheet	2 from 2