

EDCON-COMPONENTS

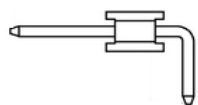

Specifications

Current Rating: 3 Ampere
 Insulator Resistance: 1000 Megaohm min.
 Dielectric Withstanding: AC 500V
 Operating Temperature: -40°C to +105°C
 Contact Material: Brass
 Insulator Material: Polyester, (Nylon 6T UL 94V-0)

Contact Plating: Tin, Gold or Selective Plated
 Standard: Gold Flash Overall
 Selectiv Plating: Gold flash plated on contact area /
 tin plated on solder area

P.C.B Layout

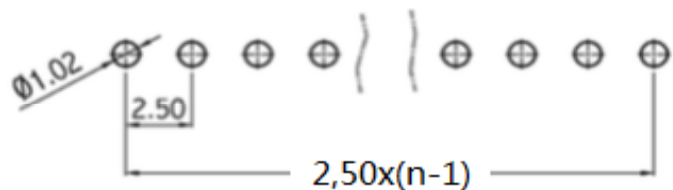

Drawing (dimensions all into mm)

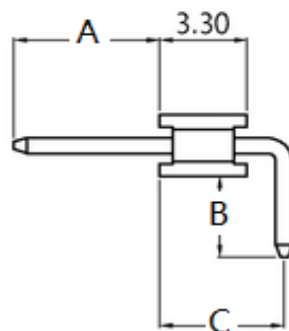

Left Side to >>>>>>> Right side

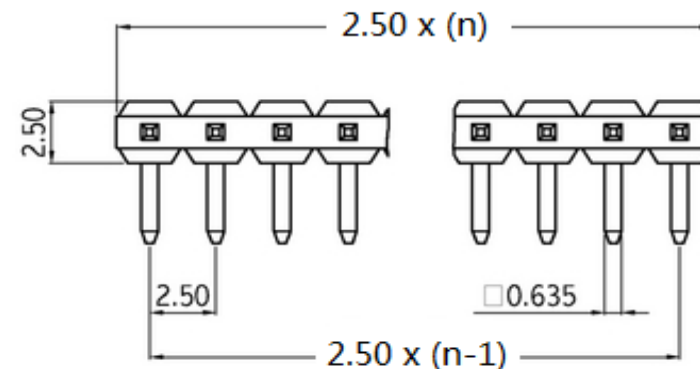

PIN Header / Single Row / Single
 Body / Pitch 2,50mm

Part No.: **T5111002-**

Customer:

DRW:	Jason	CHKD	Wilson	MATL:	Wilson	TOLERANCE	Mason	DATE	31.01.2017
APPD:	Schumi			FINISH	Jamy		Sheet No.	1 from 4	

EDCON-COMPONENTS

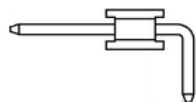

Pin Code length table free configuration

Order Code	Dimension (mm)		
	A	B	C
A01	3,50	3,30	4,70
A02	4,80	3,30	4,70
A03	6,10	3,30	4,70
A04	9,90	3,30	4,70
A05	15,00	3,30	4,70
A06			
A07			
A08			
A09			
A10			
A11			
A12			
A13			
A14			
A15			
A16			
A17			
A18			
A19			
A20			
A21			
A22			

Order Code	Dimension (mm)		
	A	B	C
A23			
A24			
A25			
A26			
A27			
A28			
A29			
A30			
A31			
A32			
A33			
A34			
A35			
A36			
A37			
A38			
A39			
A40			
A41			
A42			
A43			
A44			

Order Code	Dimension (mm)		
	A	B	C
A45			
A46			
A47			
A48			
A49			
A50			
A51			
A52			
A53			
A54			
A55			
A56			
A57			
A58			
A59			
A60			
A61			
A62			
A63			
A64			
A65			
A66			

PIN Header / Single Row / Single Body / Pitch 2,50mm

Part No.: **T5111002-**

Customer:

DRW:	Jason	CHKD	Wilson	MATL:	Wilson	TOLERANCE	Mason	DATE	31.01.2017
APPD:	Schumi			FINISH	Jamy		Sheet No.		2 from 4

EDCON-COMPONENTS

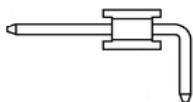

Ordering Informations

Serie	No. of Pos.	Construction	Contact Plating	Material	Special function	Pin Length Code	ROHS	Packing		
T51I1002-	XX	RT	G0	PB	B1	A01	R	BU		

XX = total pin of header	ST = Straight Pin THT	G0 = Gold Flash (Standard)	PB =P.B.T (Standard)	B1 = empty Pin 2+3 from left to right	look table page 2	N =NO ROHS conform	BU = Bulk (Standard)
		T0 = Tin plated	PY = Polyester UL94V-0			R =ROHS conform	TU = Tube w/o Cap
		GA = 10µ Gold Plating	NY = Nylon-6T				TC = Tube w. pic and Place Cap
		GB = 15µ Gold Plating					TY = Tray packing w/o Cap
		GC = 20µ Gold Plating					TR = Tape/Reel w. pic and Place Cap
		S0 = Selectiv Plating Gold Flash / Tin					
		TN = Tin Plated					

PIN Header / Single Row / Single Body / Pitch 2,50mm

Part No.: **T51I1002-**

DRW:	Jason	CHKD	Wilson	MATL:	Wilson	TOLERANCE	Mason	DATE	31.01.2017
APPD:	Schumi			FINISH	Jamy		Sheet No.		3 from 4

Customer:

EDCON-COMPONENTS

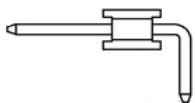

Soldering Profile for Lead Soldering (P.B.T.)

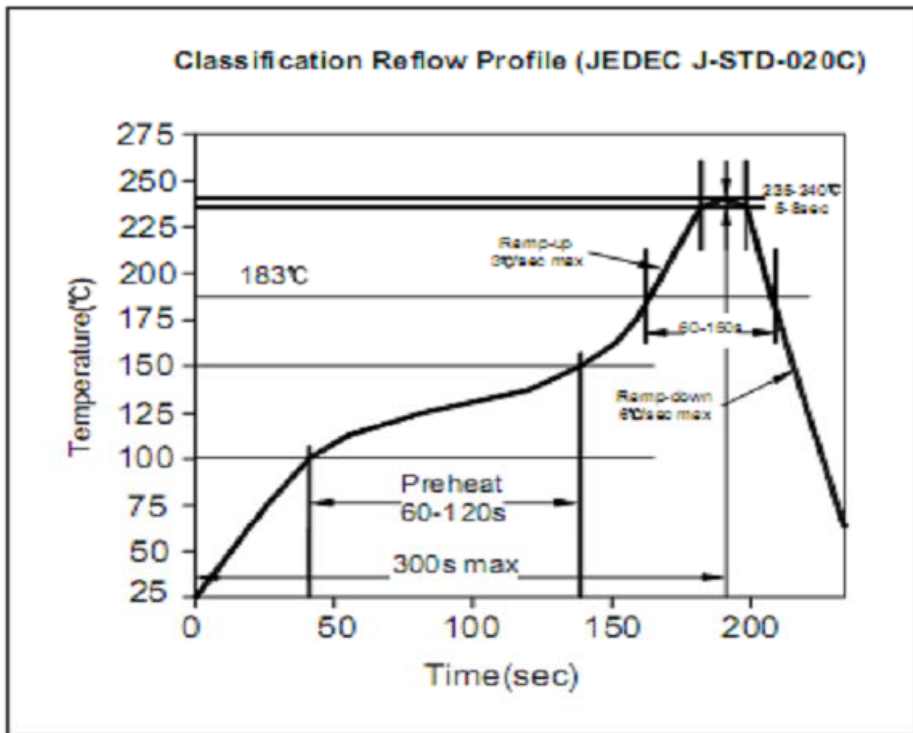

Soldering Profile for Lead Free Soldering (Nylon 6T)

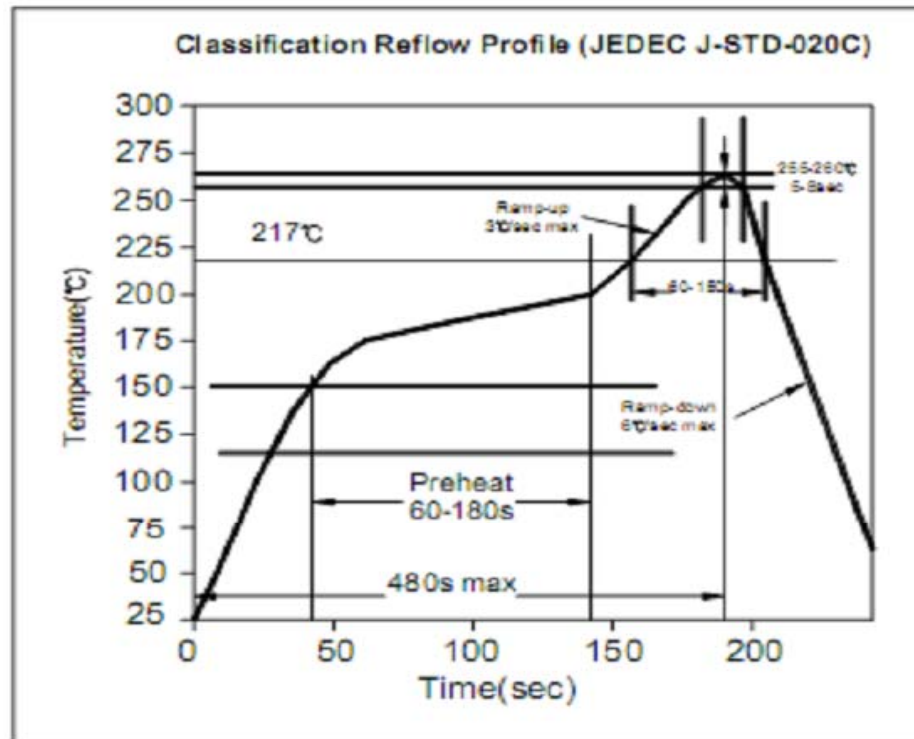

PIN Header / Single Row / Single Body / Pitch 2,50mm

Part No.: **T5111002-**

DRW:	Jason	CHKD	Wilson	MATL:	Wilson	TOLERANCE	Mason	DATE	31.01.2017
APPD:	Schumi			FINISH	Jamy		Sheet No.	4 from 4	Customer:

www.edcon-components.com

email: info@edcon-components.com