

EDCON-COMPONENTS

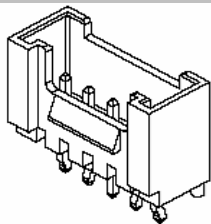

Specifications

Voltage Rating:	250 V AC/DC
Current Rating:	3A AC/DC
Operating Temperature:	-25°C to + 85°C
Contact Resistance:	30 mΩ
Withstanding Voltage:	1000 V AC/Minute
Insulation Resistance:	1000MΩ min.
Material Housing:	Nylon 46T / UL94V-0
Color of Base:	Natural (Beige)
Pin-Material:	Brass / Gold Flash plated

Drawing (dimensions all into mm)

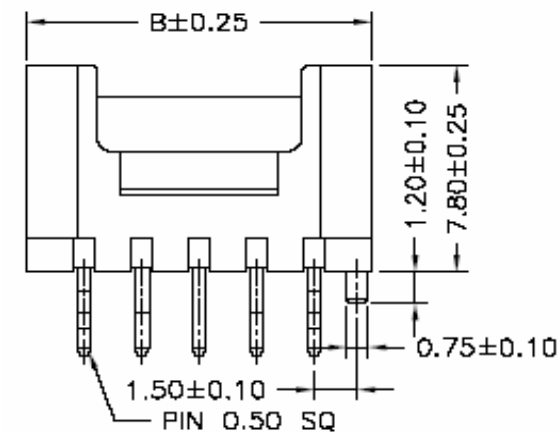
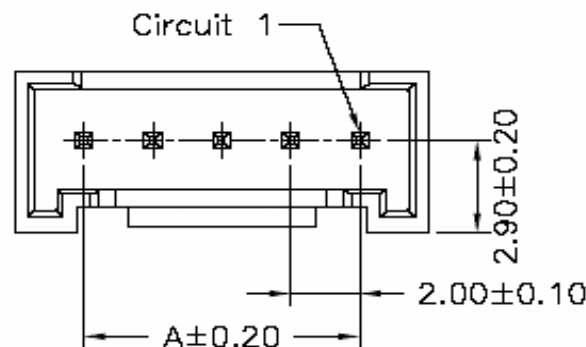

P.C.B. Layout

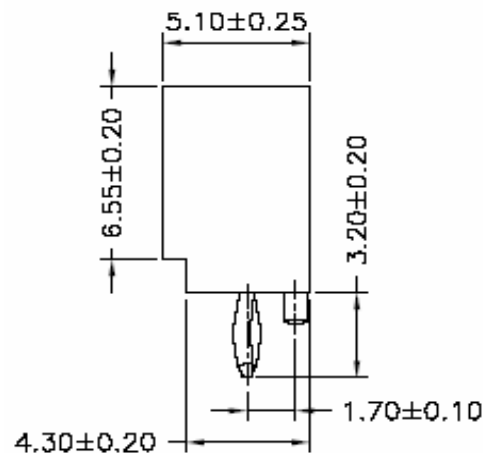
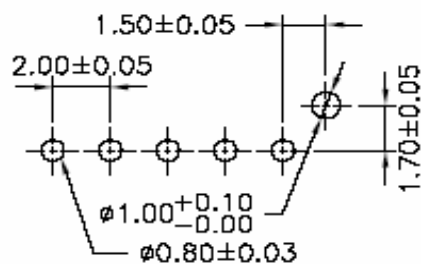

Wafer Serie T68Txxxx Pitch
2,00mm

Part No.: **T68T307**

DRW:	Jason	CHKD	Wilson	MATL:	Wilson	TOLERANCE	Mason	DATE	02.04.2009
APPD:	Schumi			FINISH	Jamy		Sheet No.	1 from 4	Customer:

EDCON-COMPONENTS

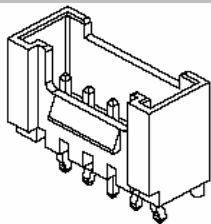

Ordering Informations

Serie	Number of Pos.	Leg Function	Color of Body	Packing						
-------	----------------	--------------	---------------	---------	--	--	--	--	--	--

T68T307	02	K	BG	BU						
----------------	-----------	----------	-----------	-----------	--	--	--	--	--	--

xx = Pos.	K= with King	BG= Beige	BU= Bulk Ware						

Wafer Serie T68Txxxx Pitch 2,00mm
Part No.: T68T307
Customer:

DRW:	Jason	CHKD	Wilson	MATL:	Wilson	TOLERANCE	Mason	DATE	02.04.2009
APPD:	Schumi			FINISH	Jamy		Sheet No.		3 from 4

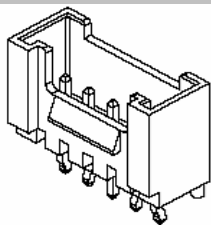

Soldering Profile Curve

Classification Reflow Profile (JEDEC J-STD-020C)

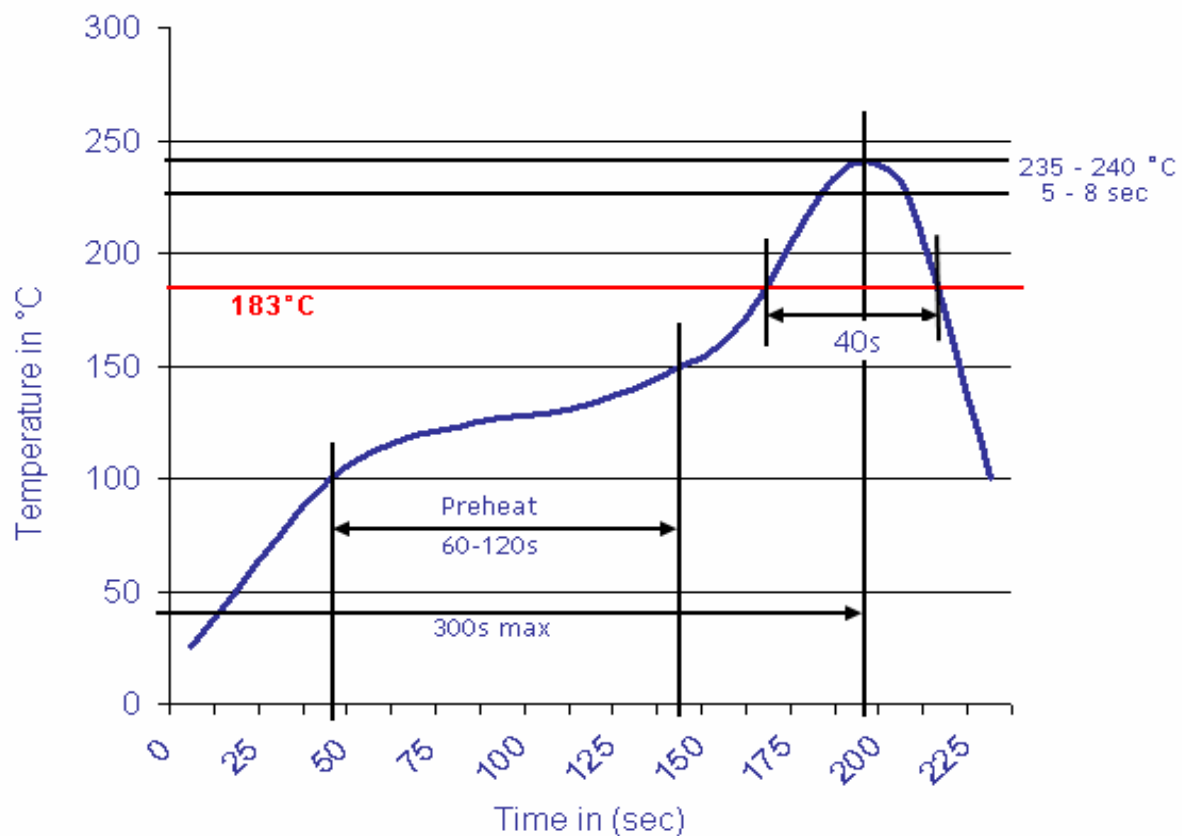

Wafer Serie T68Txxxx Pitch
2,00mm

Part No.: **T68T307**

DRW:	Jason	CHKD	Wilson	MATL:	Wilson	TOLERANCE	Mason	DATE	02.04.2009
APPD:	Schumi			FINISH	Jamy		Sheet No.	4 from 4	Customer: