

EDCON-COMPONENTS

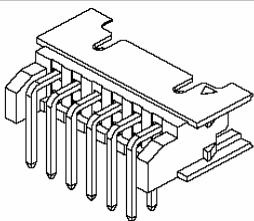

Specifications

Voltage Rating:	250 V AC/DC
Current Rating:	3A AC/DC
Operating Temperature:	-25°C to + 85°C
Contact Resistance:	10 mΩ
Withstanding Voltage:	800 V AC/Minute
Insulation Resistance:	1000MΩ min.
Material Housing:	Nylon 66 / UL94V-0
Pin-Material:	Brass / Gold Flash
Color of Base:	Natural (Beige)

Drawing (dimensions all into mm)

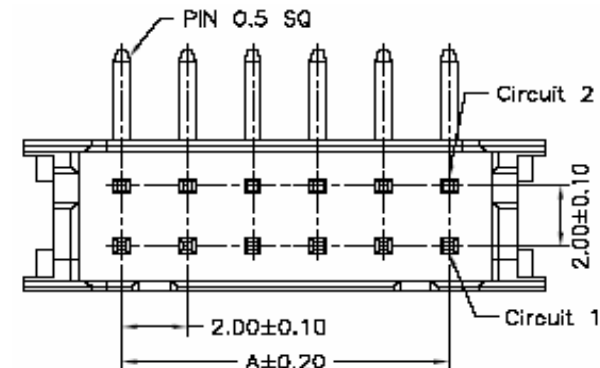
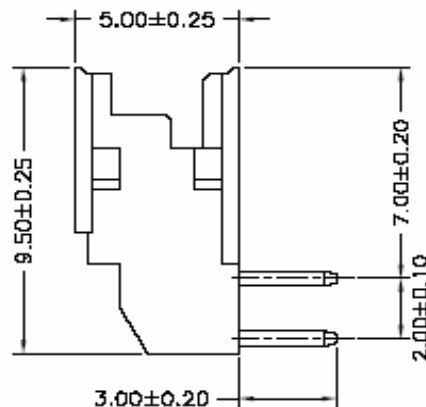

P.C.B. Layout

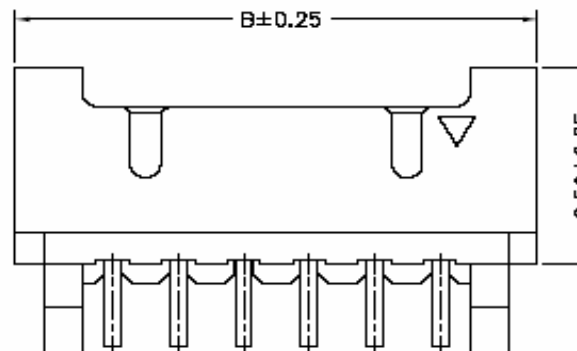
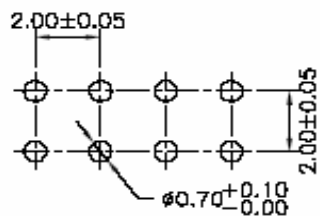

Wafer Serie T68T303 Pitch 2,00mm
Part No.: T68T303
Customer:

DRW:	Jason	CHKD	Wilson	MATL:	Wilson	TOLERANCE	Mason	DATE	12.04.2013
APPD:	Schumi			FINISH	Jamy		Sheet No.		1 from 4

www.edcon-components.com

email: info@edcon-components.com

EDCON-COMPONENTS

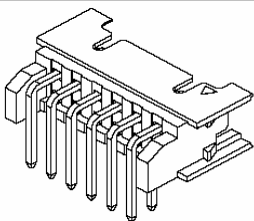

Dimension Information about Housing

Pos.	Dimension (mm)					
	A	B	C	D	E	F
04 (2x02)	2,00	8,00				
06 (2x03)	4,00	10,00				
08 (2x04)	6,00	12,00				
10 (2x05)	8,00	14,00				
12 (2x06)	10,00	16,00				
14 (2x07)	12,00	18,00				
16 (2x08)	14,00	20,00				
18 (2x09)	16,00	22,00				
20 (2x10)	18,00	24,00				
22 (2x11)	20,00	26,00				
24 (2x12)	22,00	28,00				
26 (2x13)	24,00	30,00				
28 (2x14)	26,00	32,00				
30 (2x15)	28,00	34,00				
32 (2x16)	30,00	36,00				
34 (2x17)	32,00	38,00				
36 (2x18)	34,00	40,00				
38 (2x19)	36,00	42,00				
40 (2x20)	38,00	44,00				

Pos.	Dimension (mm)					
	A	B	C	D	E	F

Wafer Serie T68T303 Pitch
2,00mm

Part No.: **T68T303**

Customer:

DRW:	Jason	CHKD	Wilson	MATL:	Wilson	TOLERANCE	Mason	DATE	12.04.2013
APPD:	Schumi			FINISH	Jamy		Sheet No.		2 from 4

EDCON-COMPONENTS

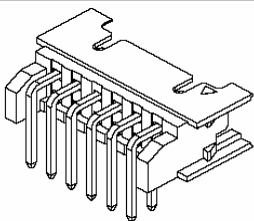

Ordering Informations

Serie	Number of Pos.	Contact Plating	special Function	Color of Body	Packing					
-------	----------------	-----------------	------------------	---------------	---------	--	--	--	--	--

T68T303	04	GF	N	WH	BU					
----------------	-----------	-----------	----------	-----------	-----------	--	--	--	--	--

xx = Pos.	GF= Gold Flash	N= no function	WH= White	BU= Bulk Ware					
	TN= Tin plated		BG= Beige						

Wafer Serie T68T303 Pitch 2,00mm
Part No.: T68T303
Customer:

DRW:	Jason	CHKD	Wilson	MATL:	Wilson	TOLERANCE	Mason	DATE	12.04.2013
APPD:	Schumi			FINISH	Jamy		Sheet No.		3 from 4

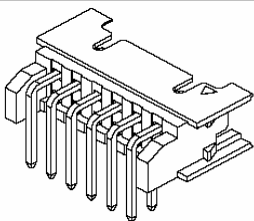

Soldering Profile Curve

Classification Reflow Profile (JEDEC J-STD-020C)

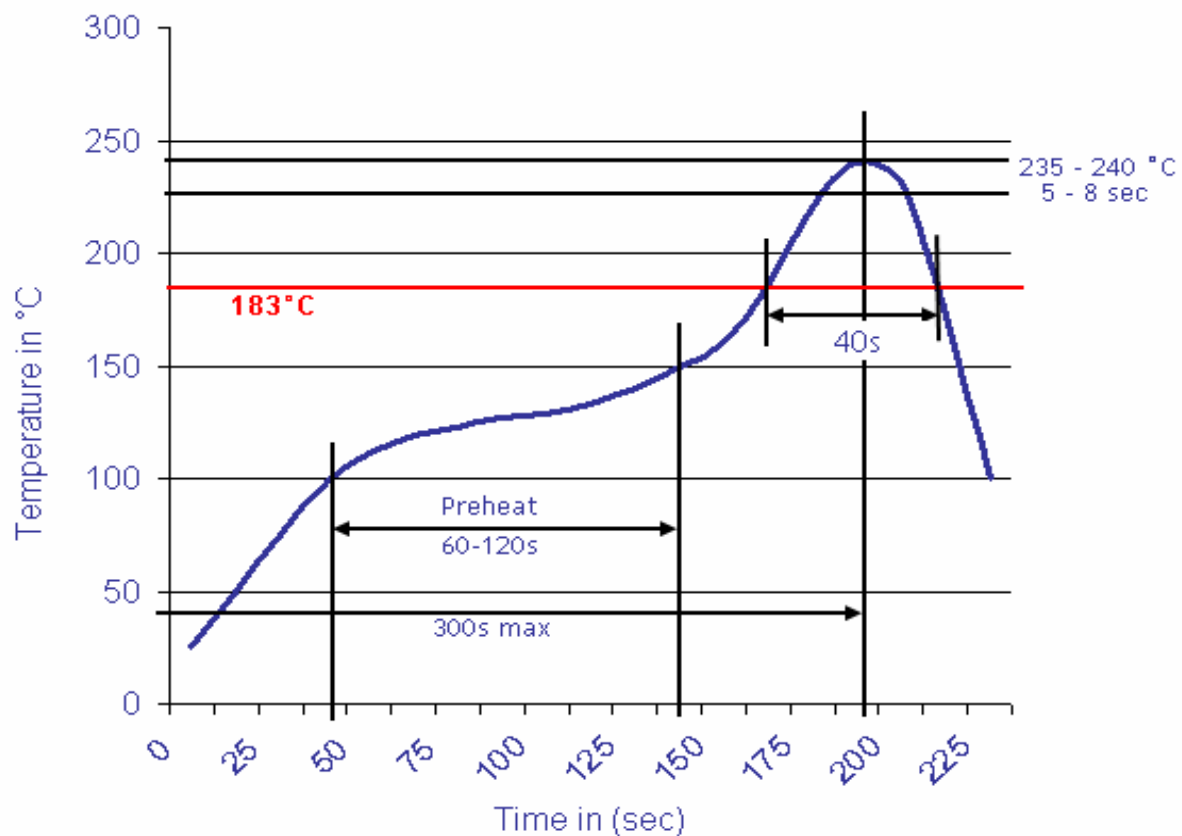

Wafer Serie T68T303 Pitch 2,00mm	
Part No.:	T68T303
Customer:	

DRW:	Jason	CHKD	Wilson	MATL:	Wilson	TOLERANCE	Mason	DATE	12.04.2013
APPD:	Schumi			FINISH	Jamy		Sheet No.	4 from 4	