

EDCON-COMPONENTS



Specifications

Voltage Rating:	125V AC,DC
Current Rating	2A AC/DC
Operating Temperature	-25°C ~ + 85°C
Contact Resistance	20 milli Ohm max.
Withstanding Voltage	1000V AC/minute
Insulation Resistance	1000 M Ohm min.
Material Pin:	Phosphor Bronze
Contact Plating:	Tin

Drawing (dimensions all into mm)

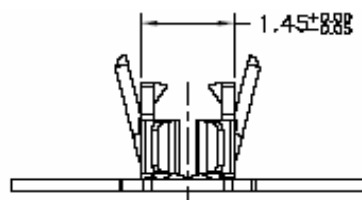
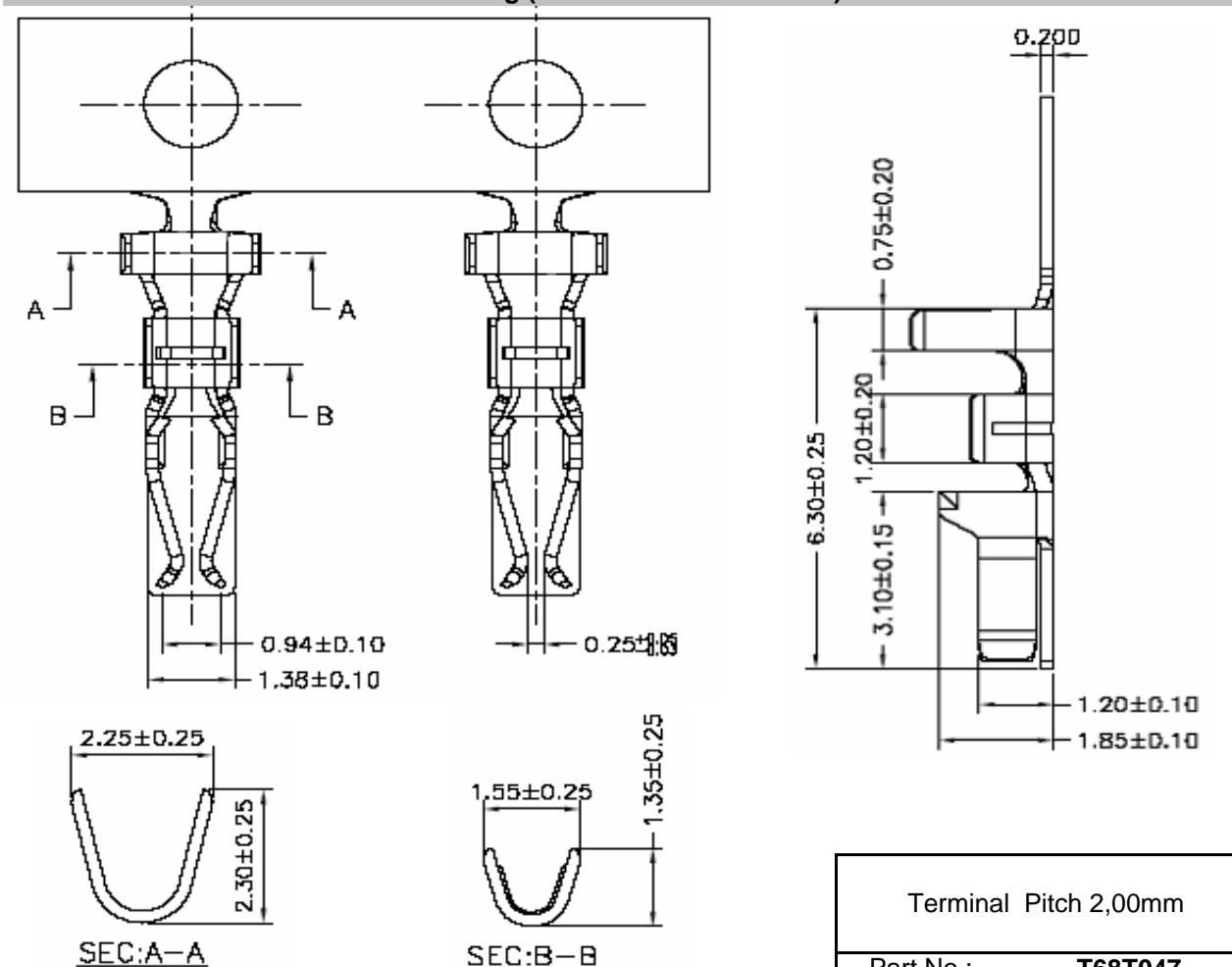

Terminal Pitch 2,00mm
Part No.: T68T047
Customer:

DRW:	Jason	CHKD	Wilson	MATL:	Wilson	TOLERANCE	Mason	DATE	02.04.2009
APPD:	Schumi			FINISH	Jamy		Sheet No.		1 from 2

EDCON-COMPONENTS



Ordering Informations

Serie	Contact	Wire Size	Packing						
T68T047	T	30	TR103						

T= Tin	30 = AWG 22~ 30	TR103= Tape/Reel 10000PCS							

Terminal Pitch 2,00mm
Part No.: T68T047
Customer:

DRW:	Jason	CHKD	Wilson	MATL:	Wilson	TOLERANCE	Mason	DATE	02.04.2009
APPD:	Schumi			FINISH	Jamy		Sheet No.	2 from 2	

www.edcon-components.com

email: info@edcon-components.com