

EDCON-COMPONENTS

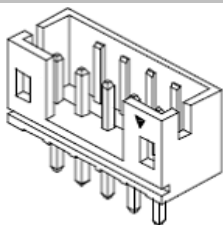

Specifications

Voltage Rating:	100 V AC/DC
Current Rating:	2A AC/DC
Operating Temperature:	-25°C to + 85°C
Contact Resistance:	10 mΩ
Withstanding Voltage:	500 V AC/Minute
Insulation Resistance:	1000MΩ min.
Material Housing:	Nylon 6T / UL94V-0
Color:	Natural (White)
Pin-Material:	Brass /Tin-plated

Drawing (dimensions all into mm)

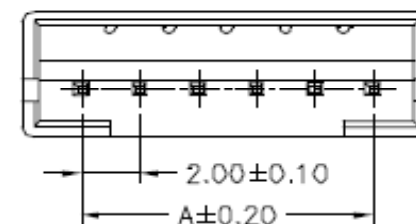
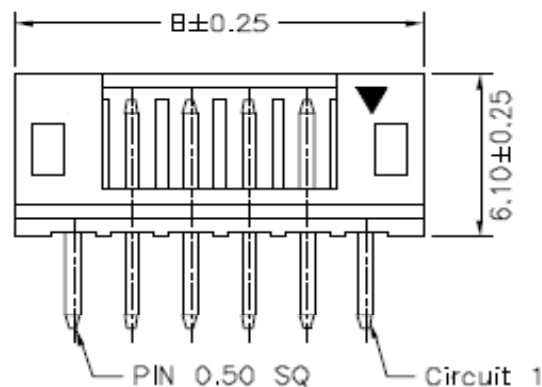

P.C.B. Layout

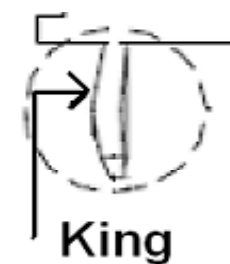
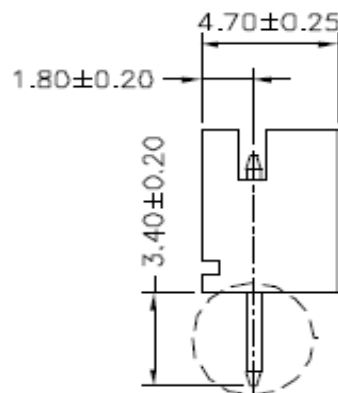
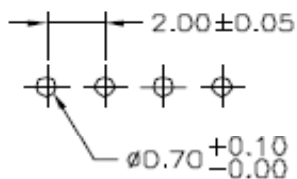

Wafer Serie T68Txxxx Pitch
2,00mm

Part No.: **T68T018**

Customer:

DRW:	Jason	CHKD	Wilson	MATL:	Wilson	TOLERANCE	Mason	DATE	28.04.2017
APPD:	Schumi			FINISH	Jamy		Sheet No.	1 from 4	

EDCON-COMPONENTS

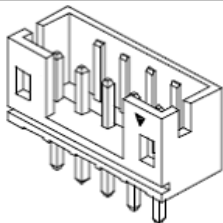

Dimension Information about Housing

Pos.	Dimension (mm)					
	A	B	C	D	E	F
2	2,00	6,00				
3	4,00	8,00				
4	6,00	10,00				
5	8,00	12,00				
6	10,00	14,00				
7	12,00	16,00				
8	14,00	18,00				
9	16,00	20,00				
10	18,00	22,00				
11	20,00	24,00				
12	22,00	26,00				
13	24,00	28,00				
14	26,00	30,00				
15	28,00	32,00				
16	30,00	34,00				
17	32,00	36,00				
18	34,00	38,00				

Pos.	Dimension (mm)					
	A	B	C	D	E	F

Wafer Serie T68Txxxx Pitch 2,00mm	
Part No.:	T68T018
Customer:	

DRW:	Jason	CHKD	Wilson	MATL:	Wilson	TOLERANCE	Mason	DATE	28.04.2017
APPD:	Schumi			FINISH	Jamy		Sheet No.	2 from 4	

EDCON-COMPONENTS

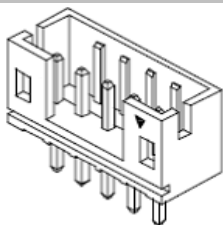

Ordering Informations

Serie	Number of Pos.	Leg Function	Color of Body	Packing	Special					
-------	----------------	--------------	---------------	---------	---------	--	--	--	--	--

T68T018	02	N	WH	BU	UV					
----------------	-----------	----------	-----------	-----------	-----------	--	--	--	--	--

xx = Pos.	N= without King	WH= White (Standard)	BU= Bulk Ware	UV= Ultraviolet					
	K= with King	BL= Blue							
		RD= Red							
		YE= Yellow							
		GN= Green							
		BK= Black							
		Other Colors MOQ on request							

Wafer Serie T68Txxxx Pitch 2,00mm
Part No.: T68T018
Customer:

DRW:	Jason	CHKD	Wilson	MATL:	Wilson	TOLERANCE	Mason	DATE	28.04.2017
APPD:	Schumi			FINISH	Jamy		Sheet No.		3 from 4

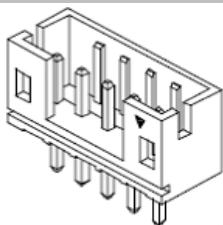

Soldering Profile Curve

Classification Reflow Profile (JEDEC J-STD-020C)

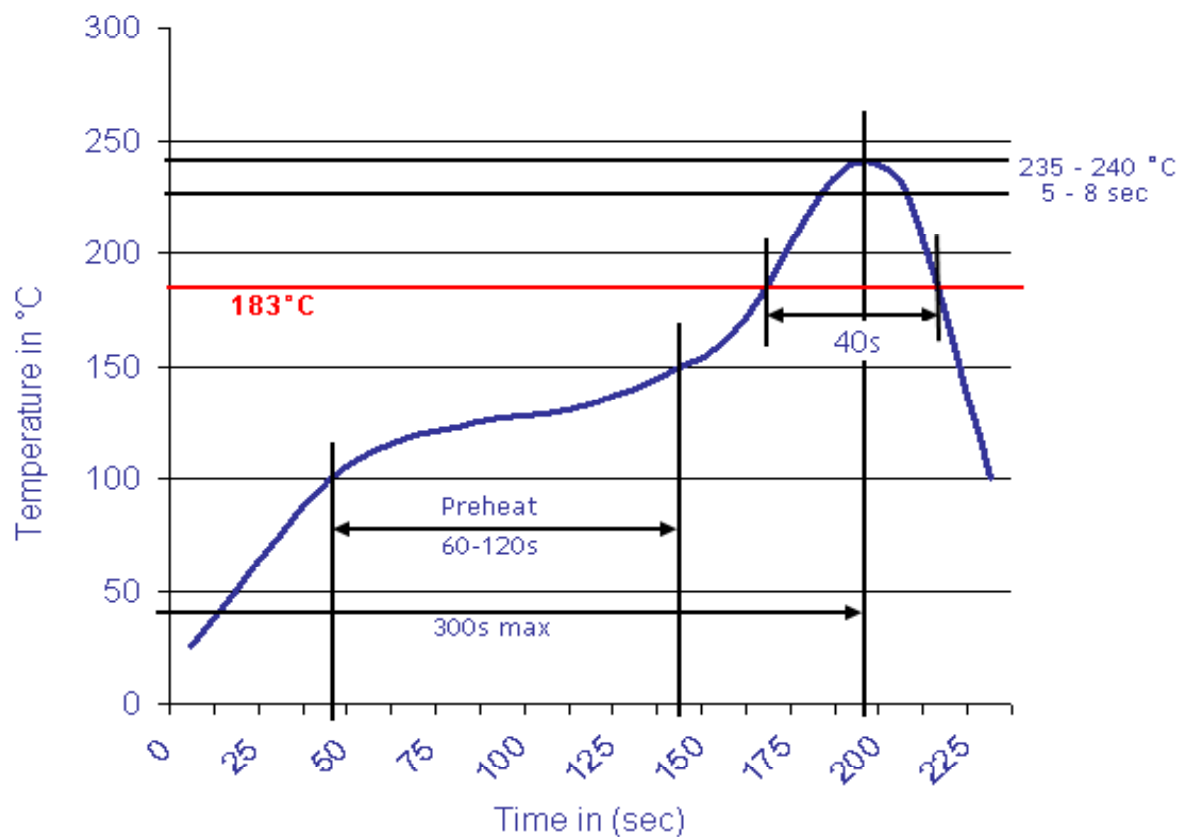

Wafer Serie T68Txxxx Pitch
2,00mm

Part No.: **T68T018**

DRW:	Jason	CHKD	Wilson	MATL:	Wilson	TOLERANCE	Mason	DATE	28.04.2017
APPD:	Schumi			FINISH	Jamy		Sheet No.	4 from 4	Customer: