

EDCON-COMPONENTS

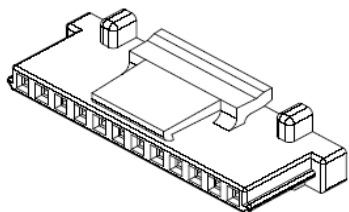

Specifications

Voltage Rating:	150 V AC/DC
Current Rating:	1A AC/DC
Operating Temperature:	-25°C to +85°C
Contact Resistance:	30 mΩ
Withstanding Voltage:	500 V AC/Minute
Insulation Resistance:	500MΩ min.
Material Housing:	Nylon 66 / UL94V-0

Drawing (dimensions all into mm)

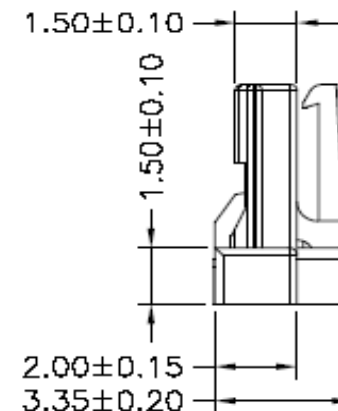
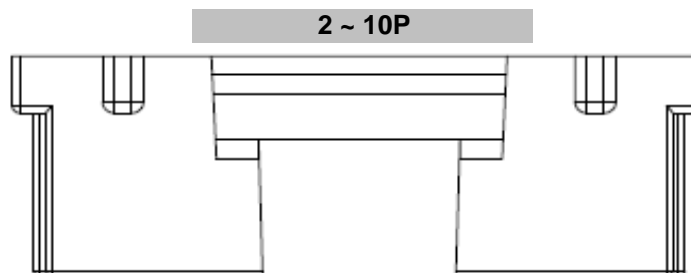
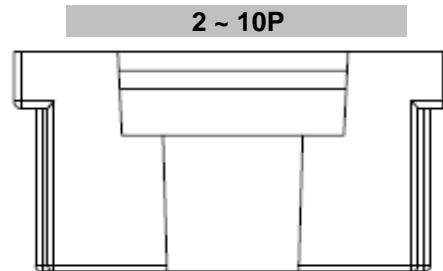
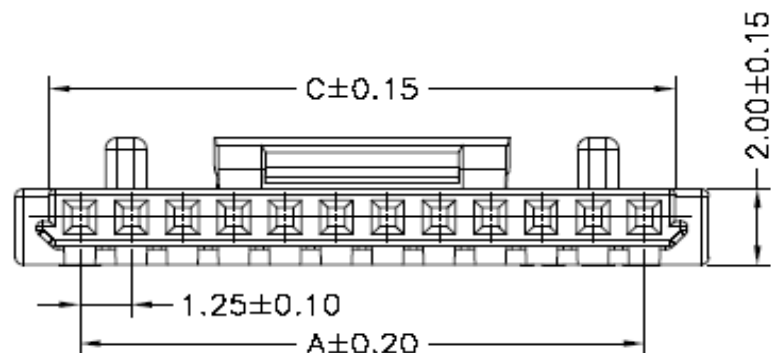

Housing Serie T68Sxxxx Pitch 1,25mm	
Part No.:	T68S022
Customer:	

DRW:	Jason	CHKD	Wilson	MATL:	Wilson	TOLERANCE	Mason	DATE	02.04.2009
APPD:	Schumi			FINISH	Jamy		Sheet No.	1 from 3	

www.edcon-components.com

email: info@edcon-components.com

EDCON-COMPONENTS

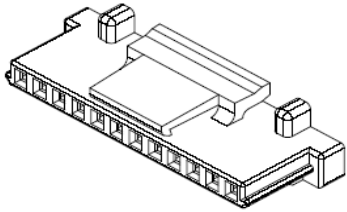

Dimension Information about Housing

Pos.	Dimension (mm)					
	A	B	C	D	E	F
2	1,25	4,40	2,75			
3	2,50	5,65	4,00			
4	3,75	6,90	5,25			
5	5,00	8,15	6,50			
6	6,25	9,40	7,75			
7	7,50	10,65	9,00			
8	8,75	11,90	10,25			
9	10,00	13,15	11,50			
10	11,25	14,40	12,75			
11	12,50	15,65	14,00			
12	13,75	16,90	15,25			
13	15,00	18,15	16,50			
14	16,25	19,40	17,75			
15	17,50	20,65	19,00			
20	23,75	26,90	25,25			
25	30,00	33,15	31,50			
30	36,25	39,40	37,75			

Pos.	Dimension (mm)					
	A	B	C	D	E	F



Housing Serie T68Sxxxx Pitch 1,25mm
Part No.: T68S022
Customer:

DRW: Jason	CHKD: Wilson	MATL: Wilson	TOLERANCE: Mason	DATE: 02.04.2009
APPD: Schumi		FINISH: Jamy	Sheet No.	2 from 3

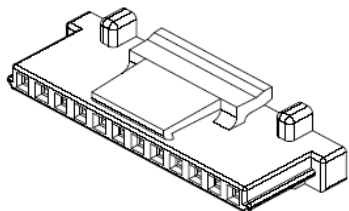

Ordering Informations

Serie	Number of Pos.	Look	Packing						
-------	----------------	------	---------	--	--	--	--	--	--

T68S022	02	Y	BU						
----------------	-----------	----------	-----------	--	--	--	--	--	--

xx = Pos.	Y= With Ears	BU= Bulk Packing							



Housing Serie T68Sxxxx Pitch 1,25mm	
Part No.:	T68S022
Customer:	

DRW:	Jason	CHKD	Wilson	MATL:	Wilson	TOLERANCE	Mason	DATE	02.04.2009
APPD:	Schumi			FINISH	Jamy			Sheet No.	3 from 3