

EDCON-COMPONENTS

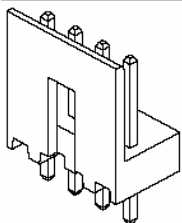

Specifications

Voltage Rating: 250 V AC/DC
 Current Rating: 3A AC/DC
 Operating Temperature: -25°C to +85°C
 Contact Resistance: 10 mΩ
 Withstanding Voltage: 800 V AC/Minute
 Insulation Resistance: 500MΩ min.
 Material Housing: Nylon 66 / UL94V-0

Pin-Material: Brass /Tin-plated
 Color of Base: White

Drawing (dimensions all into mm)

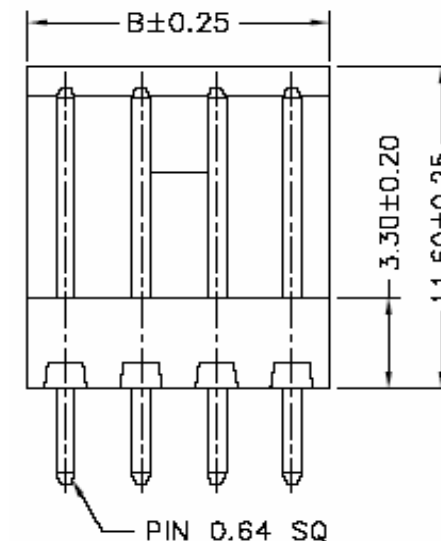
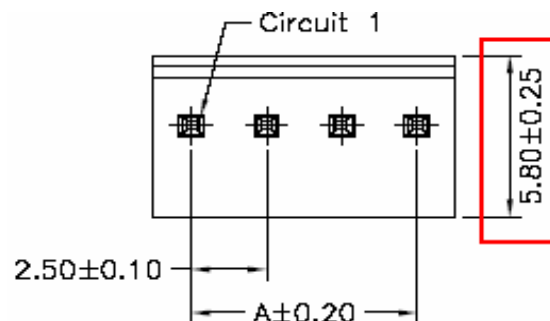

P.C.B. Layout

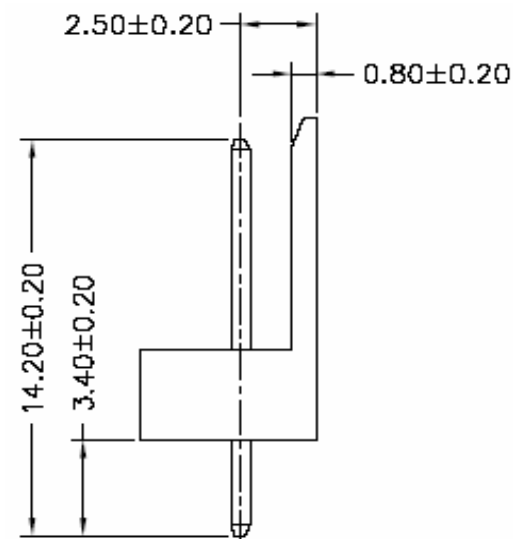
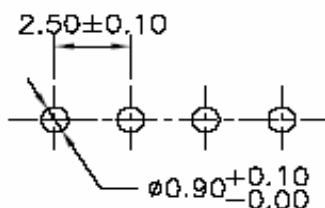

Wafer Serie T68Pxxxx Pitch
2,50mm

Part No.: **T68P054**

Customer:

DRW:	Jason	CHKD	Wilson	MATL:	Wilson	TOLERANCE	Mason	DATE	02.04.2009
APPD:	Schumi			FINISH	Jamy		Sheet No.	1 from 4	

EDCON-COMPONENTS

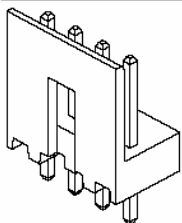

Ordering Informations

Serie	Number of Pos.	Leg Function	Color of Body	Packing						
-------	----------------	--------------	---------------	---------	--	--	--	--	--	--

T68P054	02	N	WH	BU						
----------------	-----------	----------	-----------	-----------	--	--	--	--	--	--

xx = Pos.	N= without Kink	WH= White	BU= Bulk Ware							

Wafer Serie T68Pxxxx Pitch 2,50mm
Part No.: T68P054
Customer:

DRW:	Jason	CHKD	Wilson	MATL:	Wilson	TOLERANCE	Mason	DATE	02.04.2009
APPD:	Schumi			FINISH	Jamy			Sheet No.	3 from 4

www.edcon-components.com

email: info@edcon-components.com

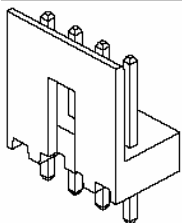

Soldering Profile Curve

Classification Reflow Profile (JEDEC J-STD-020C)

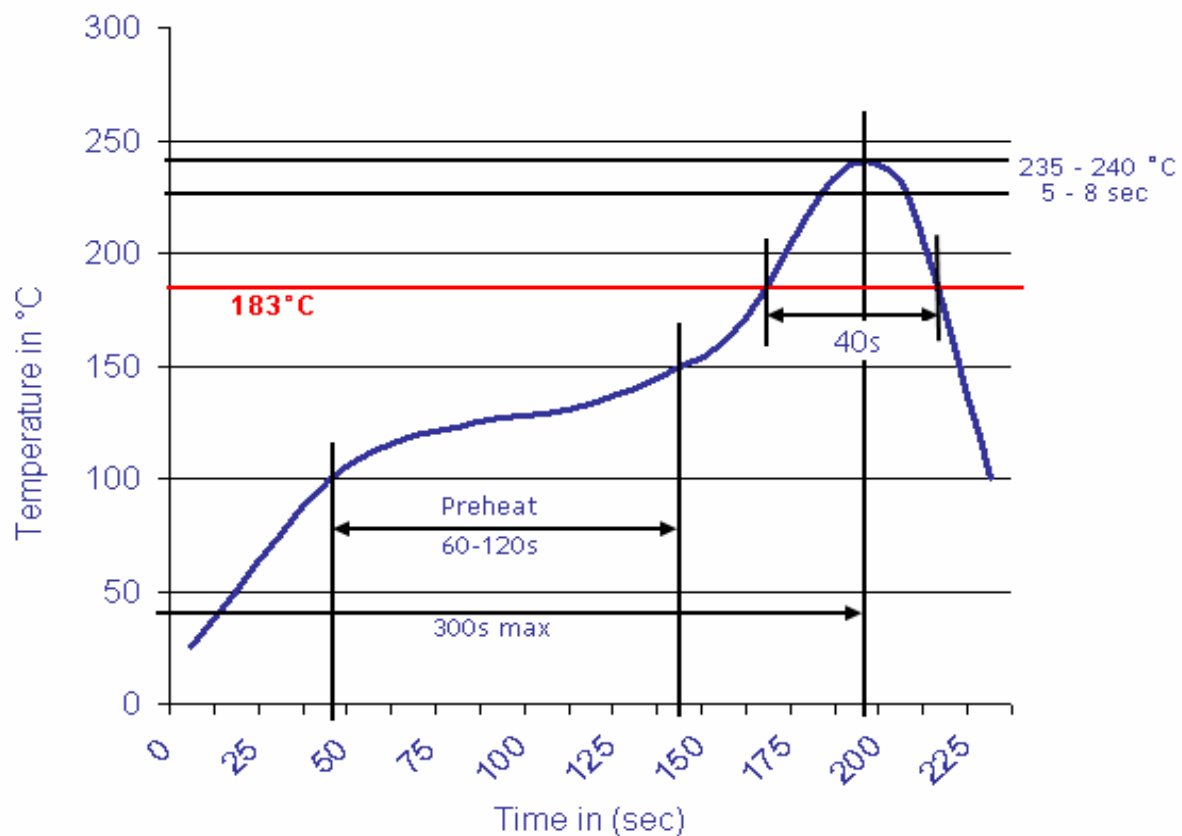

Wafer Serie T68Pxxxx Pitch 2,50mm
Part No.: T68P054
Customer:

DRW:	Jason	CHKD	Wilson	MATL:	Wilson	TOLERANCE	Mason	DATE	02.04.2009
APPD:	Schumi			FINISH	Jamy		Sheet No.	4 from 4	