

EDCON-COMPONENTS

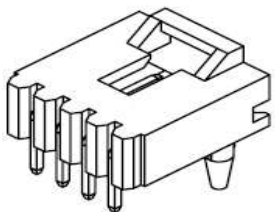

Specifications

Voltage Rating: 250 V AC/DC
 Current Rating: 3A AC/DC
 Operating Temperature: -40°C to + 105°C
 Contact Resistance: 20 mΩ
 Withstanding Voltage: 1500 V AC/Minute
 Insulation Resistance: 1000MΩ min.
 Material Housing: PBT30% GF / UL94V-0

Pin-Material: Brass / Gold-flash
 Color of Base: Black

P.C.B. Layout

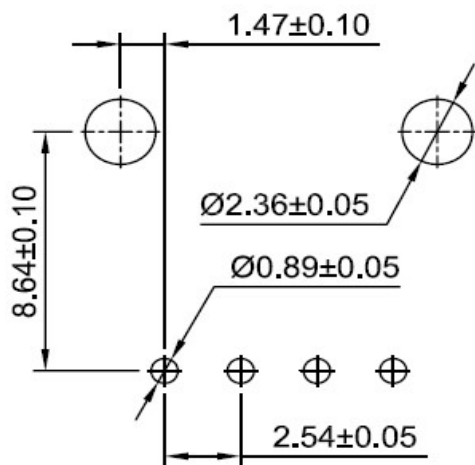

Drawing (dimensions all into mm)

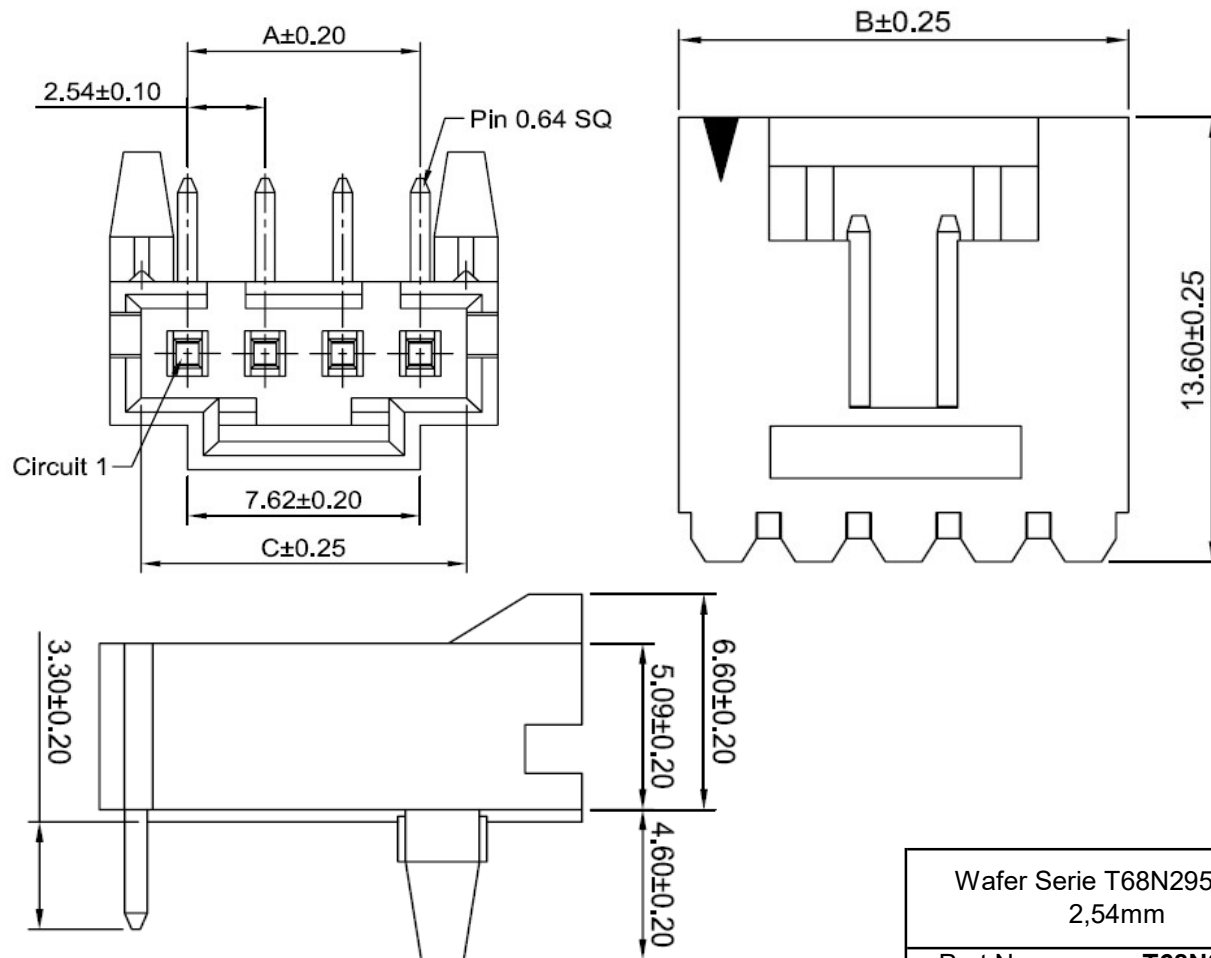

Wafer Serie T68N295 Pitch 2,54mm
Part No.: T68N339-
Customer:

DRW:	Jason	CHKD	Wilson	MATL:	Wilson	TOLERANCE	Mason	DATE	26.11.2022
APPD:	Schumi			FINISH	Jamy		Sheet No.		1 from 4

www.edcon-components.com

email: info@edcon-components.com

EDCON-COMPONENTS

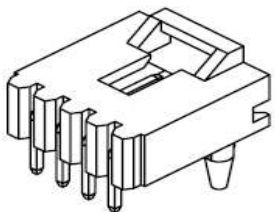

Dimension Information about Housing

Pos.	Dimension (mm)					
	A	B	C	D	E	F
2	2,54	7,62	5,59			
3	5,08	10,16	8,13			
4	7,62	12,70	10,67			
5	10,16	15,24	13,21			
6	12,70	17,78	15,75			
7	15,24	20,32	18,29			
8	17,78	22,86	20,83			
9	20,32	25,40	23,37			
10	22,86	27,94	25,91			
11	25,40	30,48	28,45			
12	27,94	33,02	30,99			
13	30,48	35,56	33,53			
14	33,02	38,10	36,07			
15	35,56	40,64	38,61			
16	38,10	43,18	41,15			
17	40,64	45,72	43,69			
18	43,18	48,26	46,23			
19	45,72	50,80	48,77			
20	48,26	53,34	51,31			
21	50,80	55,88	53,85			
22	53,34	58,42	56,39			
23	55,88	60,96	58,93			
24	58,42	63,50	61,47			
25	60,96	66,04	64,01			

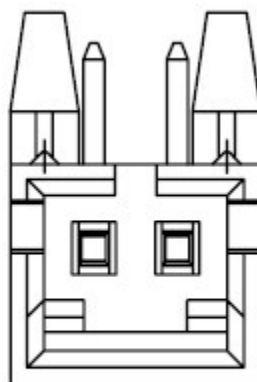

2P

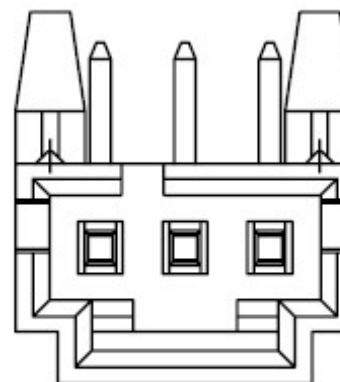

3P

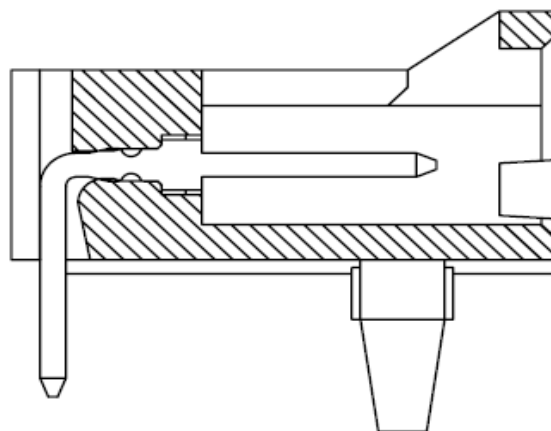

Wafer Serie T68N295 Pitch 2,54mm	
Part No.:	T68N339-
Customer:	

DRW:	Jason	CHKD	Wilson	MATL:	Wilson	TOLERANCE	Mason	DATE	26.11.2022
APPD:	Schumi			FINISH	Jamy		Sheet No.		2 from 4

EDCON-COMPONENTS

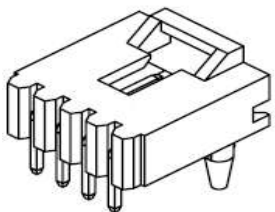

Ordering Informations

Serie	Number of Pos.	Contact Plating	Color of Body	Packing						
-------	----------------	-----------------	---------------	---------	--	--	--	--	--	--

T68N339-	XX	GF	BK	BU						
-----------------	-----------	-----------	-----------	-----------	--	--	--	--	--	--

xx = Pos.	TN= Tinned	BK= Black	BU= Bulk Ware							
	GF= Gold Flash (standard)		IV= Individual Packing							
	Gx = Other Contact Plating on request									

Wafer Serie T68N295 Pitch
2,54mm

Part No.: **T68N339-**

DRW:	Jason	CHKD	Wilson	MATL:	Wilson	TOLERANCE	Mason	DATE	26.11.2022
APPD:	Schumi			FINISH	Jamy		Sheet No.		3 from 4

Customer:

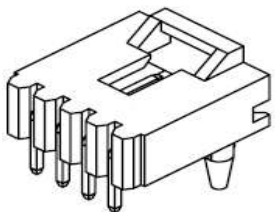

Soldering Profile Curve

Classification Reflow Profile (JEDEC J-STD-020C)

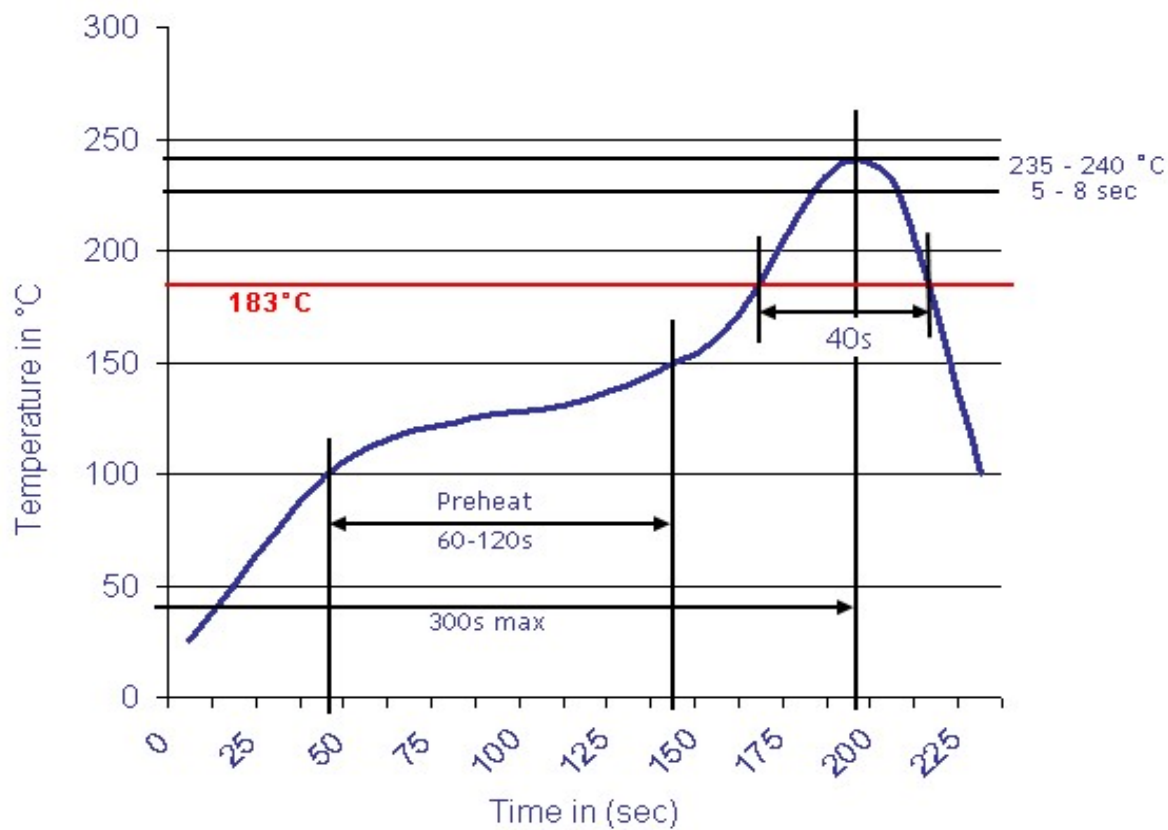

Wafer Serie T68N295 Pitch 2,54mm
Part No.: T68N339-
Customer:

DRW:	Jason	CHKD	Wilson	MATL:	Wilson	TOLERANCE	Mason	DATE	26.11.2022
APPD:	Schumi			FINISH	Jamy		Sheet No.		4 from 4