

# EDCON-COMPONENTS

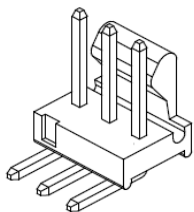

## Specifications

Voltage Rating:	250 V AC/DC
Current Rating:	4A AC/DC
Operating Temperature:	-25°C to +85°C
Contact Resistance:	10 mΩ
Withstanding Voltage:	1000 V AC/Minute
Insulation Resistance:	1000MΩ min.
Material Housing:	Nylon 66 / UL94V-2
Pin-Material:	Brass /Tin-plated
Color of Body:	Natural (White)

## Drawing ( dimensions all into mm)

Circuit 1

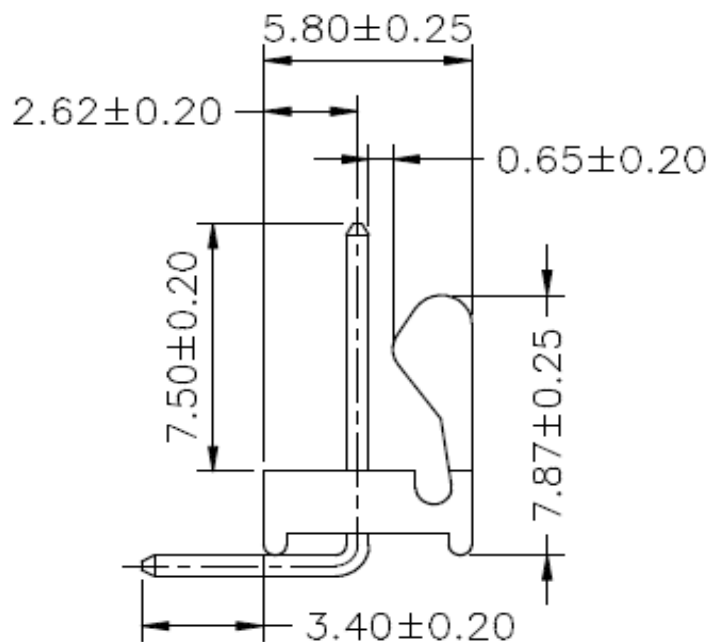
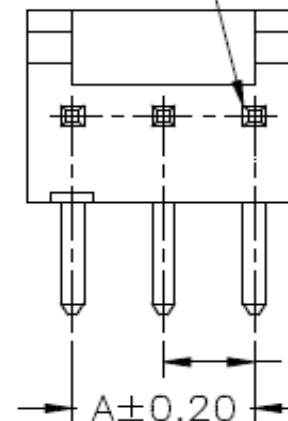

## P.C.B. Layout

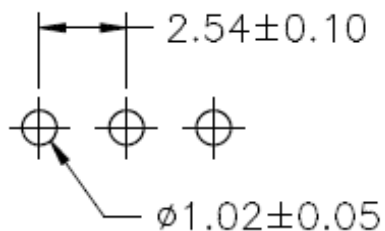

Wafer Serie T68Nxxxx Pitch  
2,54mm

Part No.: **T68N310**

Customer:

DRW:	Jason	CHKD	Wilson	MATL:	Wilson	TOLERANCE	Mason	DATE	02.04.2009
APPD:	Schumi			FINISH	Jamy		Sheet No.	1 from 4	



# EDCON-COMPONENTS

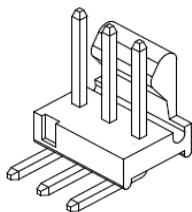

## Ordering Informations

Serie	Number of Pos.	Leg function	Color of Body	Packing						
-------	----------------	--------------	---------------	---------	--	--	--	--	--	--

<b>T68N310</b>	<b>02</b>	<b>N</b>	<b>BN</b>	<b>BU</b>						
----------------	-----------	----------	-----------	-----------	--	--	--	--	--	--

xx = Pos.	N= without King	BN= Brown	BU= Bulk-ware						

Wafer Serie T68Nxxxx Pitch 2,54mm
Part No.: <b>T68N310</b>
Customer:

DRW:	Jason	CHKD	Wilson	MATL:	Wilson	TOLERANCE	Mason	DATE	02.04.2009
APPD:	Schumi			FINISH	Jamy		Sheet No.		3 from 4

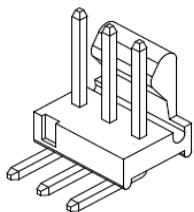

Soldering Profile Curve

Classification Reflow Profile (JEDEC J-STD-020C)

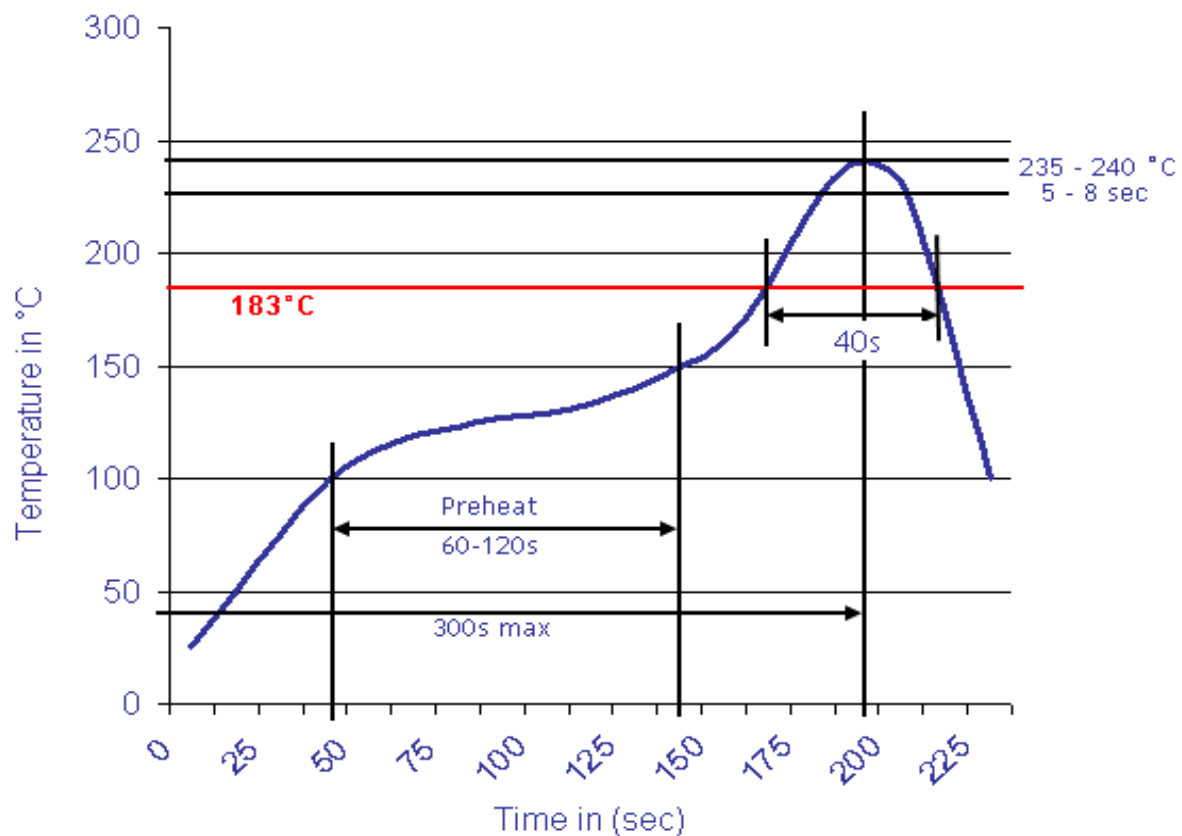

Wafer Serie T68Nxxxx Pitch  
2,54mm

Part No.: **T68N310**

DRW:	Jason	CHKD	Wilson	MATL:	Wilson	TOLERANCE	Mason	DATE	02.04.2009
APPD:	Schumi			FINISH	Jamy		Sheet No.	4 from 4	Customer: