

EDCON-COMPONENTS

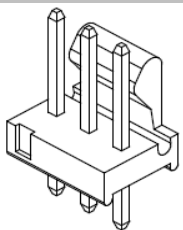

Specifications

Voltage Rating:	250 V AC/DC
Current Rating:	4A AC/DC
Operating Temperature:	-25°C to +85°C
Contact Resistance:	10 mΩ
Withstanding Voltage:	1000 V AC/Minute
Insulation Resistance:	1000MΩ min.
Material Housing:	Nylon 66 / UL94V-2
Pin-Material:	Brass /Tin-plated
Color of Body:	Natural (White)

Drawing (dimensions all into mm)

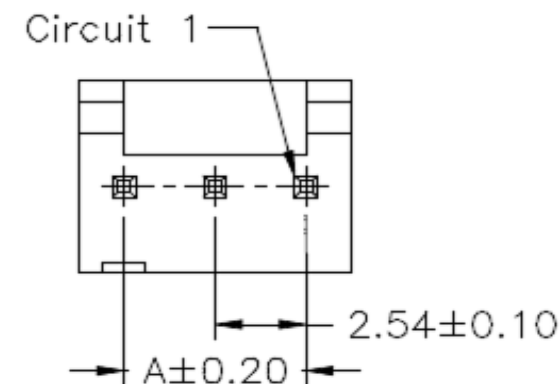
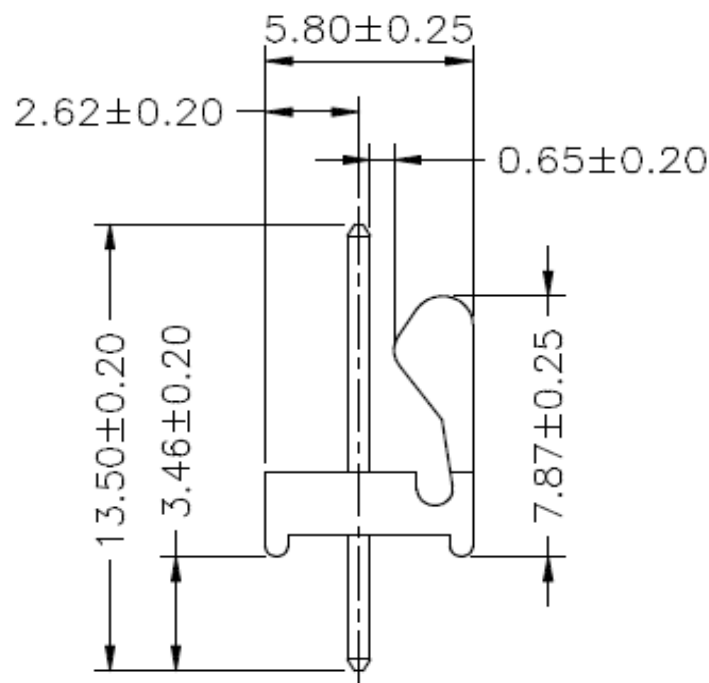

P.C.B. Layout

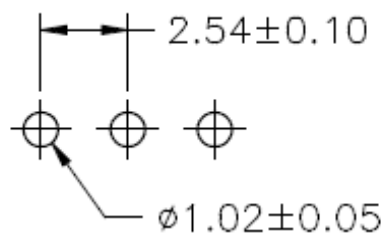

Wafer Serie T68Nxxxx Pitch
2,54mm

Part No.: **T68N037**

DRW:	Jason	CHKD	Wilson	MATL:	Wilson	TOLERANCE	Mason	DATE	02.04.2009
APPD:	Schumi			FINISH	Jamy		Sheet No.	1 from 4	Customer:

www.edcon-components.com

email: info@edcon-components.com

EDCON-COMPONENTS

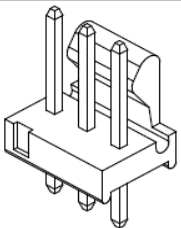

Dimension Information about Housing

Pos.	Dimension (mm)					
	A	B	C	D	E	F
2	2,54	5,08				
3	5,08	7,62				

Pos.	Dimension (mm)					
	A	B	C	D	E	F

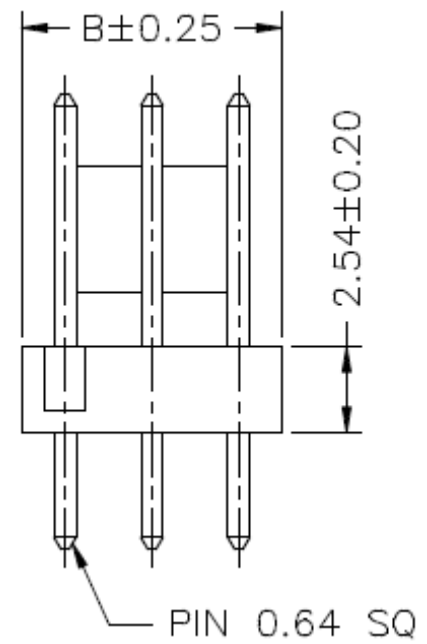

Wafer Serie T68Nxxxx Pitch 2,54mm	
Part No.:	T68N037
Customer:	

DRW:	Jason	CHKD	Wilson	MATL:	Wilson	TOLERANCE	Mason	DATE	02.04.2009
APPD:	Schumi			FINISH	Jamy		Sheet No.	2 from 4	

EDCON-COMPONENTS

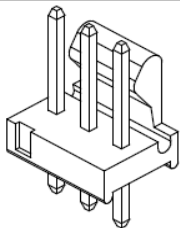

Ordering Informations

Serie	Number of Pos.	Leg function	Color of Body	Packing						
-------	----------------	--------------	---------------	---------	--	--	--	--	--	--

T68N037	02	N	WH	BU						
----------------	-----------	----------	-----------	-----------	--	--	--	--	--	--

xx = Pos.	N= without King	WH= White	BU= Bulk-ware						

Wafer Serie T68Nxxxx Pitch 2,54mm
Part No.: T68N037
Customer:

DRW:	Jason	CHKD	Wilson	MATL:	Wilson	TOLERANCE	Mason	DATE	02.04.2009
APPD:	Schumi			FINISH	Jamy		Sheet No.		3 from 4

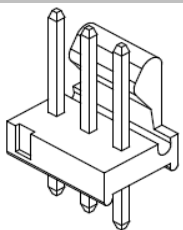

Soldering Profile Curve

Classification Reflow Profile (JEDEC J-STD-020C)



Wafer Serie T68Nxxxx Pitch
2,54mm

Part No.: **T68N037**

DRW:	Jason	CHKD	Wilson	MATL:	Wilson	TOLERANCE	Mason	DATE	02.04.2009	Customer:
APPD:	Schumi			FINISH	Jamy		Sheet No.	4 from 4		