

# EDCON-COMPONENTS

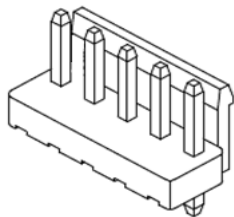

## Specifications

Voltage Rating:	250 V AC/DC
Current Rating:	7A AC/DC
Operating Temperature:	-25°C to +85°C
Contact Resistance:	10 mΩ
Withstanding Voltage:	1500 V AC/Minute
Insulation Resistance:	1000MΩ min.
Material Housing:	Nylon 66 / UL94V-0
Pin-Material:	Brass /Tin-plated
Body Color:	Natural ( White)

## Drawing ( dimensions all into mm)

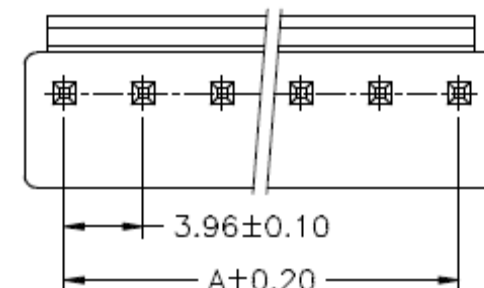
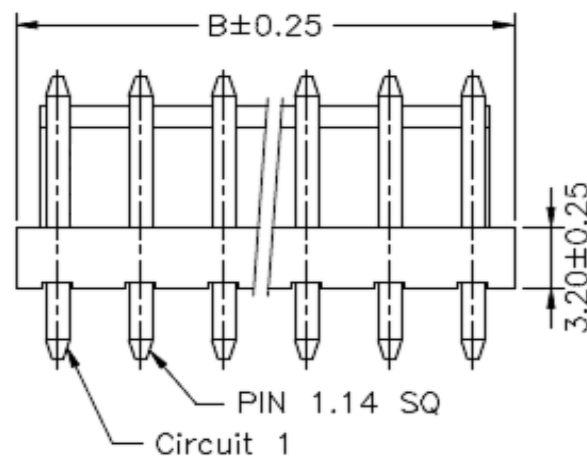

## P.C.B. Layout

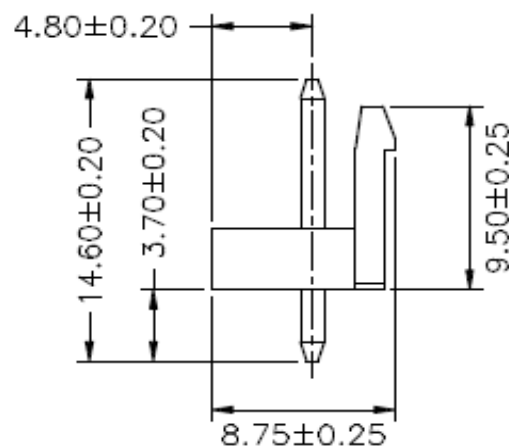
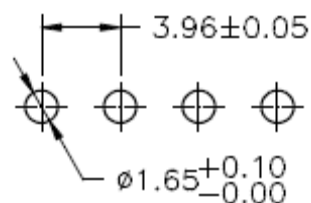

Wafer Serie T68Jxxxx Pitch  
3,96mm

Part No.: **T68J012**

Customer:

DRW:	Jason	CHKD	Wilson	MATL:	Wilson	TOLERANCE	Mason	DATE	02.04.2009
APPD:	Schumi			FINISH	Jamy		Sheet No.	1 from 4	



# EDCON-COMPONENTS

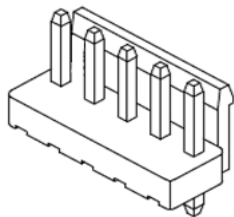

## Ordering Informations

Serie	Number of Pos.	Leg function	Color of Body	Packing						
-------	----------------	--------------	---------------	---------	--	--	--	--	--	--

<b>T68J012</b>	<b>02</b>	<b>N</b>	<b>WH</b>	<b>BU</b>						
----------------	-----------	----------	-----------	-----------	--	--	--	--	--	--

xx = Pos.	N= without King	WH= White	BU= Bulk - Ware						

Wafer Serie T68Jxxxx Pitch 3,96mm
Part No.: <b>T68J012</b>
Customer:

DRW:	Jason	CHKD	Wilson	MATL:	Wilson	TOLERANCE	Mason	DATE	02.04.2009
APPD:	Schumi			FINISH	Jamy		Sheet No.		3 from 4

[www.edcon-components.com](http://www.edcon-components.com)

email: [info@edcon-components.com](mailto:info@edcon-components.com)

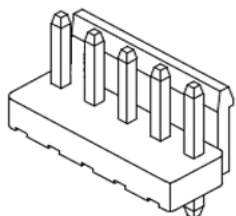

Soldering Profile Curve

Classification Reflow Profile (JEDEC J-STD-020C)

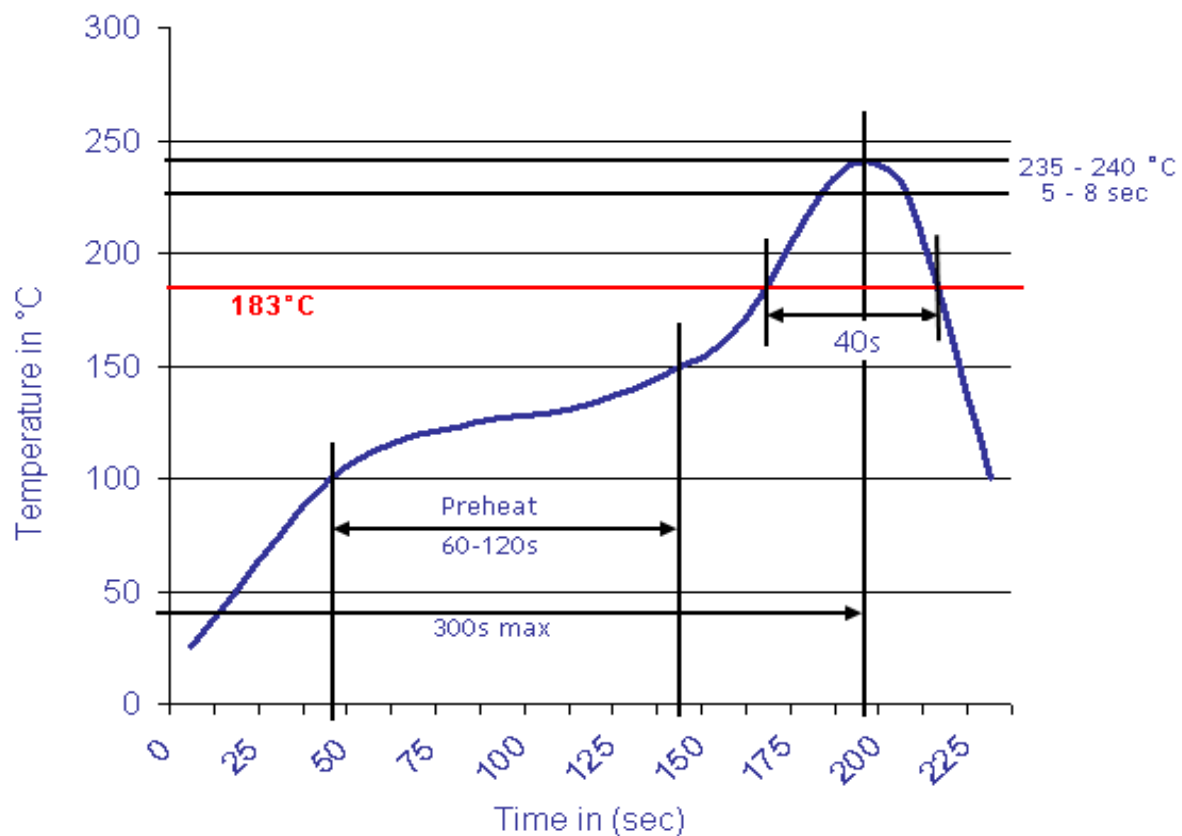

Wafer Serie T68Jxxxx Pitch 3,96mm
Part No.: <b>T68J012</b>
Customer:

DRW:	Jason	CHKD	Wilson	MATL:	Wilson	TOLERANCE	Mason	DATE	02.04.2009
APPD:	Schumi			FINISH	Jamy		Sheet No.	4 from 4	