

EDCON-COMPONENTS

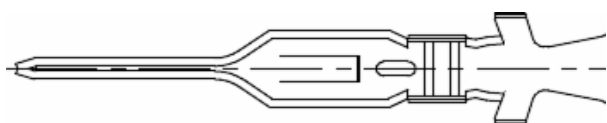

Specifications

Voltage Rating:	125V AC,DC
Current Rating	1A AC/DC
Operating Temperature	-25°C ~ + 85°C
Contact Resistance	20 milli Ohm max.
Withstanding Voltage	500V AC/minute
Insulation Resistance	500 M Ohm min.
Material Pin:	Phosphor Bronze
	Brass
Contact Plating:	Tin plated

Drawing (dimensions all into mm)

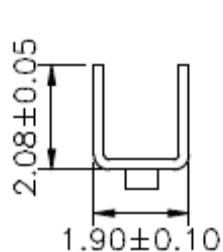
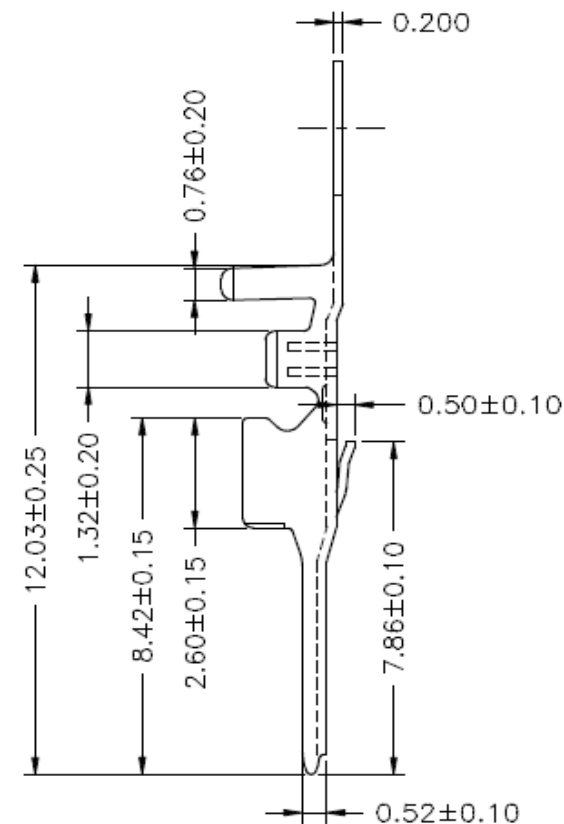
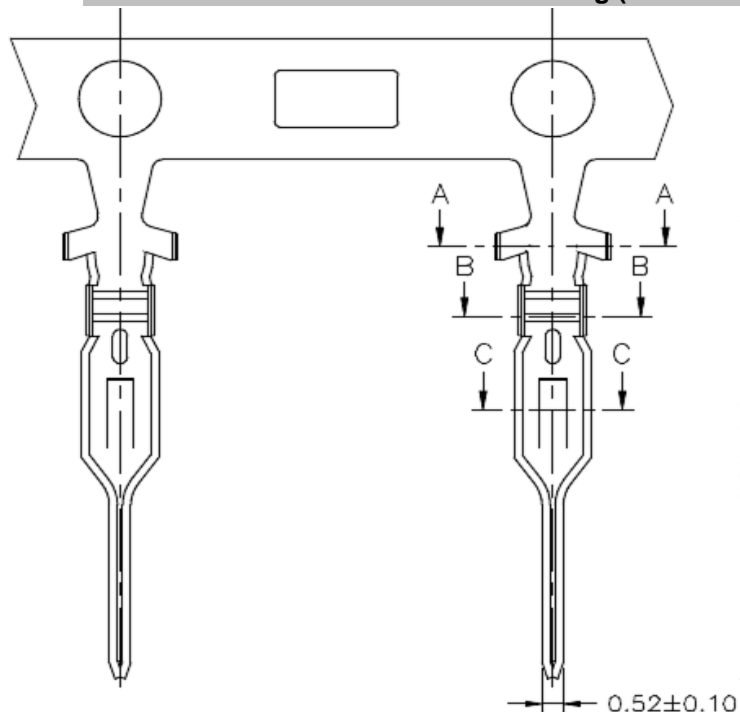

SEC:C-C

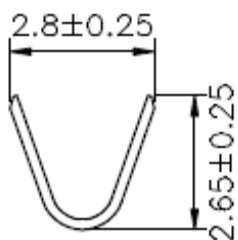

SEC:A-A

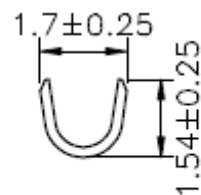

SEC:B-B

**Terminal T68Jxxx Pitch
3,96mm**

Part No.: **T68H005**

DRW:	Jason	CHKD	Wilson	MATL:	Wilson	TOLERANCE	Mason	DATE	02.04.2009
APPD:	Schumi			FINISH	Jamy		Sheet No.	1 from 2	Customer:

EDCON-COMPONENTS

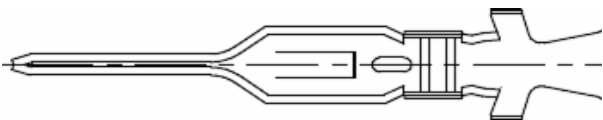

Ordering Informations

Serie	C- Material	Wire Size	Packing						
T68H005	PB	28	TR502						

PB= Phosphor Bronze	28 = AWG 24~ 28	TR502= Tape/Reel 5000PCS
----------------------------------	---------------------------	---------------------------------------

Terminal T68Jxxx Pitch 3,96mm
Part No.: T68H005
Customer:

DRW:	Jason	CHKD	Wilson	MATL:	Wilson	TOLERANCE	Mason	DATE	02.04.2009
APPD:	Schumi			FINISH	Jamy		Sheet No.	2 from 2	

www.edcon-components.com

email: info@edcon-components.com