

Features:

- 14.20mm (0.56") Three digit numeric display series.
- Standard brightness.
- Low current operation.
- Excellent character appearance.
- Easy mounting on P.C.boards or sockets.
- I.C.compatible.

Part No.:

Common Cathode	Iv TYP.(mcd)	Common Anode	Iv TYP.(mcd)
EYT-5631EH-XX	12	EYT-5631FH-XX	12
EYT-5631ES-XX	84	EYT-5631FS-XX	84
EYT-5631ED-XX	144	EYT-5631FD-XX	144
EYT-5631EUR-XX	168	EYT-5631FUR-XX	168
EYT-5631EE-XX	60	EYT-5631FE-XX	60
EYT-5631EY-XX	48	EYT-5631FY-XX	48
EYT-5631EG-XX	60	EYT-5631FG-XX	60

Description:

- Color Code & Chip characteristics: (Test Condition: IF=20mA)

Emitting Color		Dice Material	Peak Wave Length (λ_p)	Spectral Line halfwidth($\lambda_{1/2}$)	Forward Voltage(VF) Unit:V		Luminous Intensity (Iv) Unit:ucd
					Typ	Max	
H	Red	GaP/GaP	700nm	90nm	2.25	2.60	500
S	Hi Red	GaAlAs/GaAs,SH	660nm	20nm	1.85	2.20	3500
D	Super Red	GaAlAs/GaAs,DH	660nm	20nm	1.85	2.20	6000
UR	Ultra Red	GaAlAs/GaAs,DD H	660nm	20nm	1.85	2.20	7000
E	Orange	GaAsP/GaP	635nm	35nm	2.10	2.50	2500
Y	Yellow	GaAsP/GaP	585nm	35nm	2.10	2.50	2000
G	Green	GaP/GaP	570nm	30nm	2.20	2.50	2500

- -XX: Surface / Lens color :

Number	0	1	2	3	4	5
Ref Surface Color	White	Black	Gray	Red	Green	
Epoxy Color	Water clear	White diffused	Red Diffused	Green Diffused	Yellow Diffused	

Package configuration & Internal circuit diagram:

FYT-5631 Series

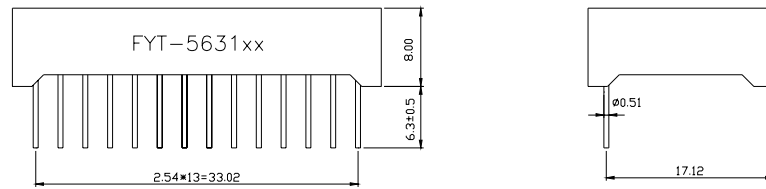
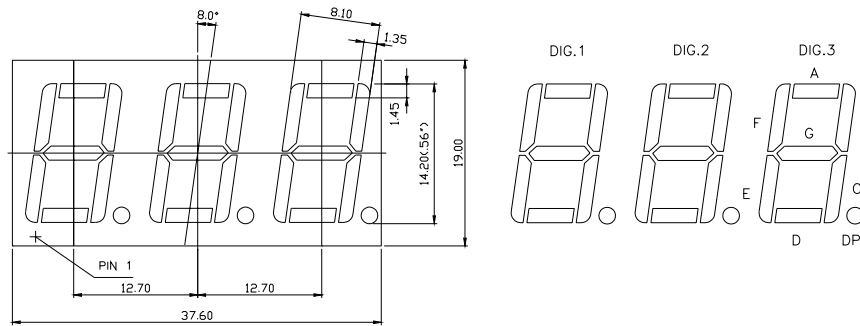

FYT-5631Ex

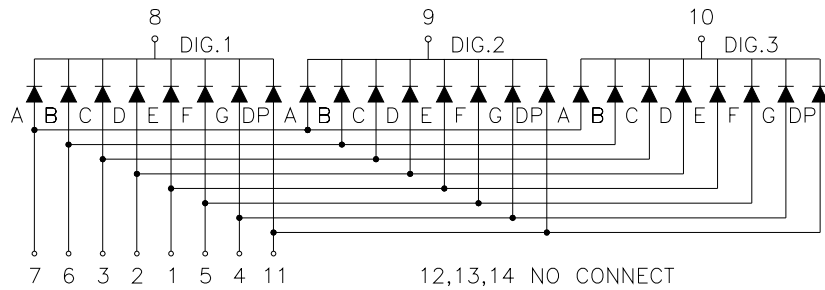

FYT-5631Fx

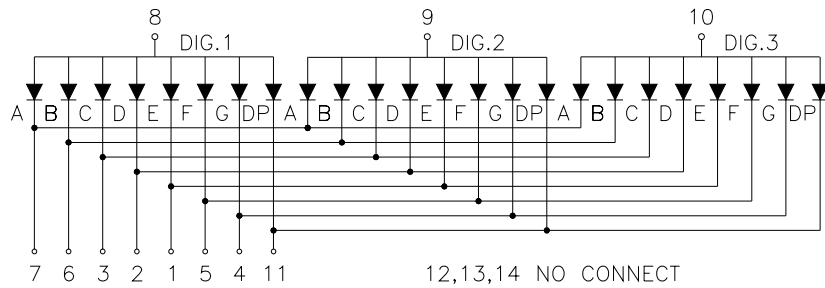

Notes:

- All dimensions are in millimeters (inches)
- Tolerance is $\pm 0.25(0.01)$ unless otherwise noted.
- Specifications are subject to change without notice.

Electrical-optical characteristics: (Ta=25)

Parameter	Symbol	GaP(Red)	AlGaAs	GaAsP	GaP(Green)	Unit
Power Dissipation	P_{ad}	40	60	80	80	mW
Peak Forward Current *	I_{pf}	50	150	150	150	mA
Continuous Forward Current	I_{af}	15	25	30	30	mA

Notes:

- * Test Condition = Duty 0.1,10KHZ

Absolute maximum ratings (Ta=25)

Reverse Voltage	5V
Reverse Current	20 μ A
Operating Temperature Range	-40 to+85
Storage Temperature Range	-40 to+85
Lead Solder Temperature (1.6mm(1/16")from body)	230 for 5 Seconds

Typical electrical-optical characteristics curves:

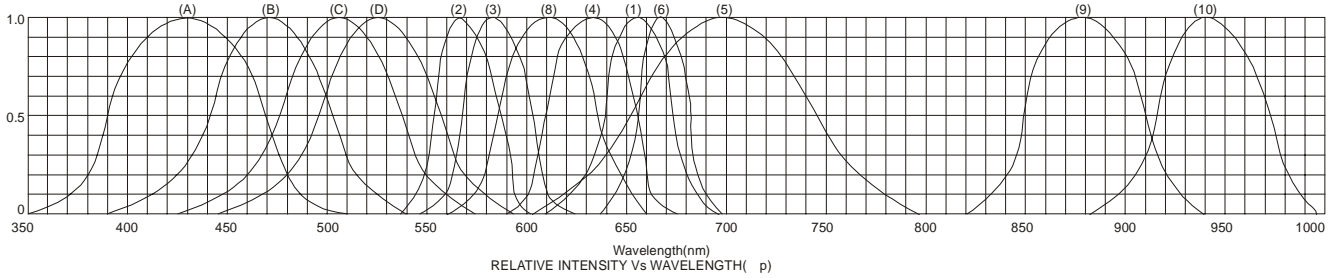

- (1) - GaAsP/GaAs 655nm/Red
- (2) - GaP 570nm/Yellow Green
- (3) - GaAsP/GaP 585nm/Yellow
- (4) - GaAsP/GaP 635nm/Orange & Hi-Eff Red
- (5) - GaP 700nm/Bright Red
- (6) - GaAlAs/GaAs 660nm/Super Red
- (8) - GaAsP/GaP 610nm/Super Red
- (9) - GaAlAs 880nm
- (10) - GaAs/GaAs & GaAlAs/GaAs 940nm
- (A) - GaN/SiC 430nm/Blue
- (B) - InGaN/SiC 470nm/Blue
- (C) - InGaN/SiC 505nm/Ultra Green
- (D) - InGaAl/SiC 525nm/Ultra Green

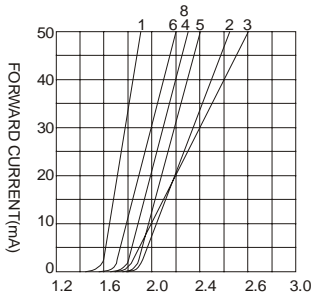

FORWARD VOLTAGE (Vf)
FORWARD CURRENT VS.
FORWARD VOLTAGE

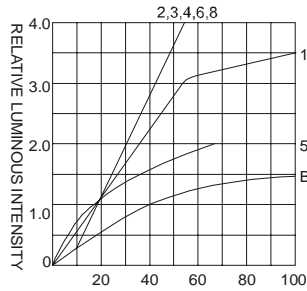

FORWARD CURRENT (mA)
RELATIVE LUMINOUS
INTENSITY VS. FORWARD
CURRENT

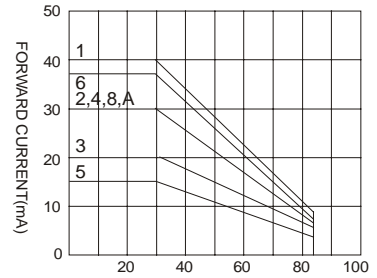

AMBIENT TEMPERATURE Ta()
FORWARD CURRENT VS. AMBIENT
TEMPERATURE

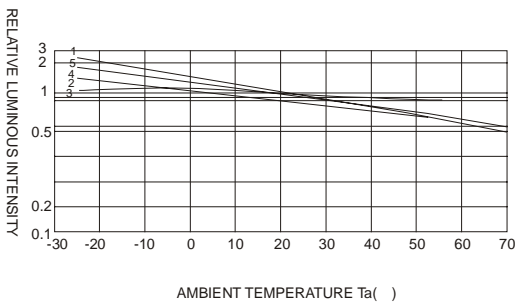

AMBIENT TEMPERATURE Ta()

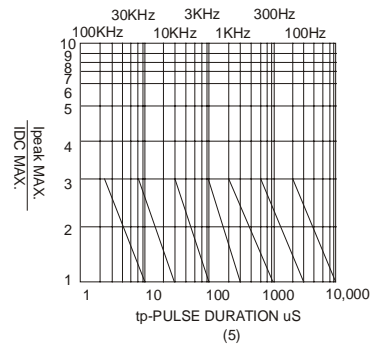
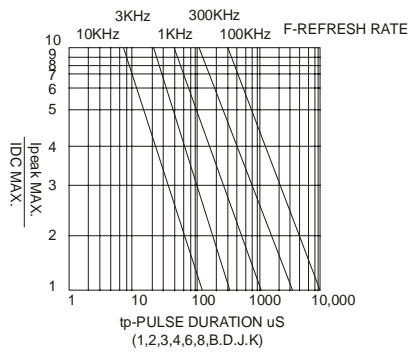

NOTE:25 free air temperature unless otherwise specified