

Features:

- 13.20mm (0.52") Four digit and Over numeric display series
- Ultra brightness
- Low current operation.
- Excellent character appearance.
- Easy mounting on P.C.boards or sockets.
- I.C.compatible.

Part No.:

Common Cathode	Iv TYP.(mcd)	Common Anode	Iv TYP.(mcd)
EYQ-5241EUHR-XX	224	EYQ-5241FUHR-XX	224
EYQ-5241EUE-XX	224	EYQ-5241FUE-XX	224
EYQ-5241EYO-XX	224	EYQ-5241FYO-XX	224
EYQ-5241EUY-XX	224	EYQ-5241FUY-XX	224
EYQ-5241EUG-XX	160	EYQ-5241FUG-XX	160
EYQ-5241EPG-XX	160	EYQ-5241FPG-XX	160
EYQ-5241EB-XX	160	EYQ-5241FB-XX	160
EYQ-5241EW-XX	160	EYQ-5241FW-XX	160

Description:

- Color Code & Chip characteristics: (Test Condition: IF=20mA)

Emitting Color		Dice Material	Peak Wave Length(I_P) (nm)	Spectral Line halfwidth($I_{1/2}$)	Forward Voltage(VF) Unit:V		Luminous Intensity (Iv) Unit:ucd
					Typ	Max	
UHR	Ultra Hi Red	AlGaInP	645nm	20nm	2.10	2.50	7000
UE	Ultra Orange	AlGaInP	630nm	20nm	2.10	2.50	7000
YO	Ultra Amber	AlGaInP	610nm	20nm	2.10	2.50	7000
UY	Ultra Yellow	AlGaInP	590nm	20nm	2.10	2.50	7000
UG	Ultra Green	AlGaInP	574nm	30nm	2.20	2.50	5000
PG	Ultra Pure Green	AlGaInP	525nm	36nm	3.80	4.50	5000
B	Blue	InGaN	430nm	30nm	3.80	4.50	5000
W	White	InGaN	-	-	3.80	4.50	5000

- -XX: Surface / Lens color :

Number	0	1	2	3	4	5
Ref Surface Color	White	Black	Gray	Red	Green	
Epoxy Color	Water clear	White diffused	Red Diffused	Green Diffused	Yellow Diffused	

Package configuration & Internal circuit diagram:

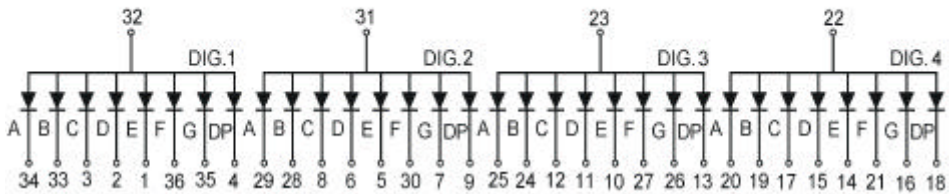
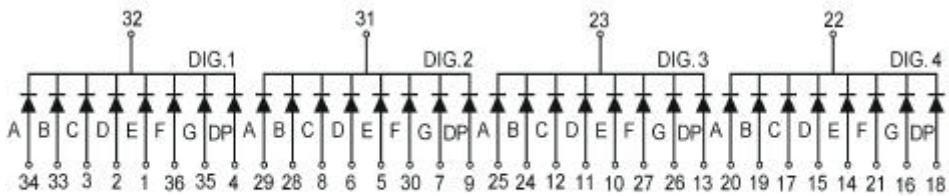
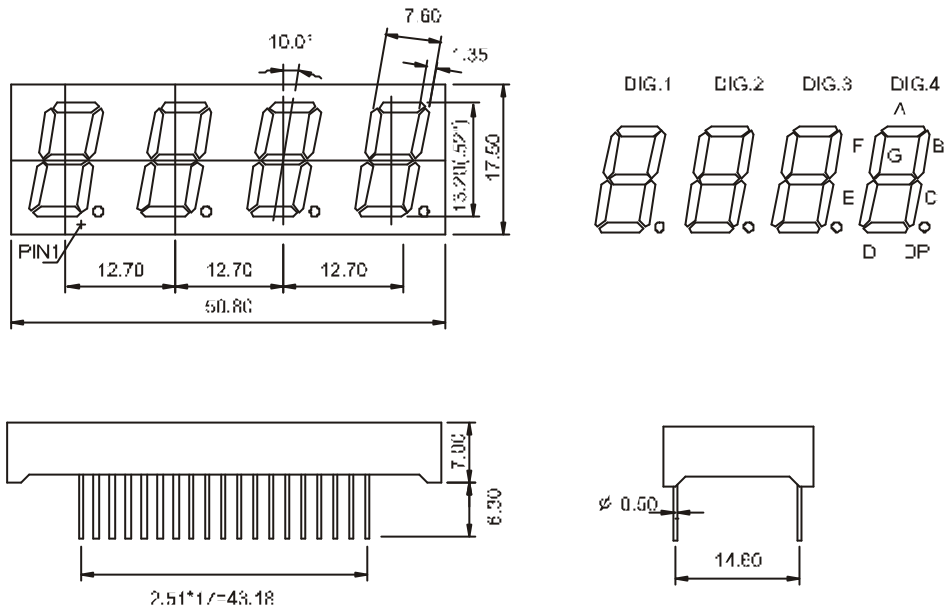

Notes:

- All dimensions are in millimeters (inches)
- Tolerance is $\pm 0.25(0.01)$ unless otherwise noted.
- Specifications are subject to change without notice.

Electrical-optical characteristics: (Ta=25)

Parameter	Symbol	AlGaInP	InGaN	Unit
Power Dissipation	P_{ad}	75	120	mW
Peak Forward Current *	I_{pf}	150	100	mA
Continuous Forward Current	I_{af}	30	30	mA

Notes:

- * Test Condition = Duty 0.1,10KHZ

Absolute maximum ratings (Ta=25)

Reverse Voltage	5V
Reverse Current	20 μ A
Operating Temperature Range	-40 to+85
Storage Temperature Range	-40 to+85
Lead Solder Temperature (1.6mm(1/16")from body)	230 for 5 Seconds

Typical electrical-optical characteristics curves:



- (1) - GaAsP/GaAs 655nm/Red
- (2) - GaP 570nm/Yellow Green
- (3) - GaAsP/GaP 585nm/Yellow
- (4) - GaAsP/GaP 635nm/Orange & Hi-Eff Red
- (5) - GaP 700nm/Bright Red
- (6) - GaAlAs/GaAs 660nm/Super Red
- (8) - GaAsP/GaP 610nm/Super Red
- (9) - GaAlAs 880nm
- (10) - GaAs/GaAs & GaAlAs/GaAs 940nm
- (A) - GaN/SiC 430nm/Blue
- (B) - InGaN/SiC 470nm/Blue
- (C) - InGaN/SiC 505nm/Ultra Green
- (D) - InGaAl/SiC 525nm/Ultra Green

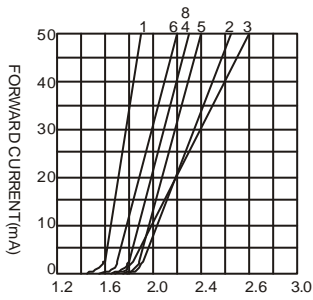

FORWARD VOLTAGE (Vf)
FORWARD CURRENT VS.
FORWARD VOLTAGE

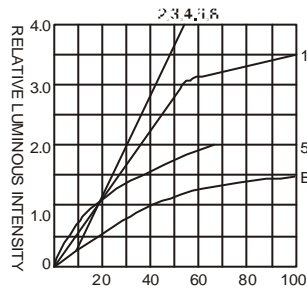

FORWARD CURRENT (mA)
RELATIVE LUMINOUS
INTENSITY VS. FORWARD
CURRENT



AMBIENT TEMPERATURE Ta($^{\circ}$)
FORWARD CURRENT VS. AMBIENT
TEMPERATURE

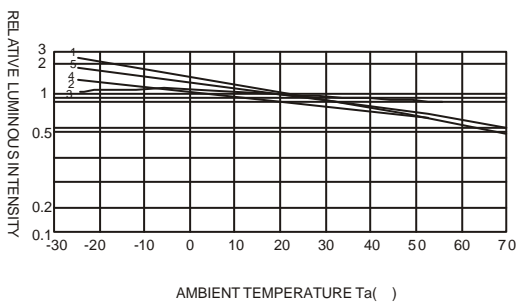

AMBIENT TEMPERATURE Ta($^{\circ}$)

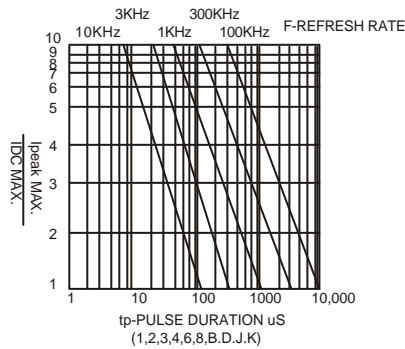

tp-PULSE DURATION μ S
(1,2,3,4,6,8,B,D,J,K)

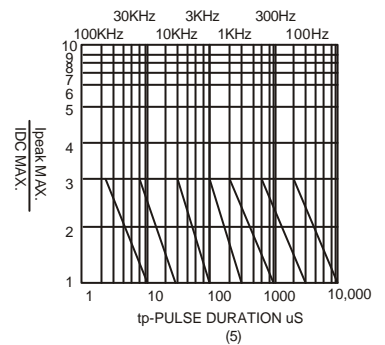

tp-PULSE DURATION μ S
(5)

NOTE:25 free air temperature unless otherwise specified