

# EDCON-COMPONENTS

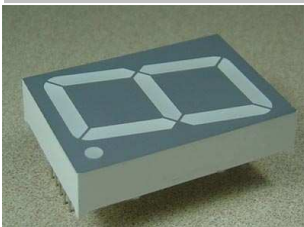

The Power of LED Light



## Dimensions / Informations Model No. 1

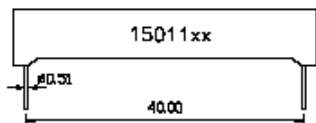
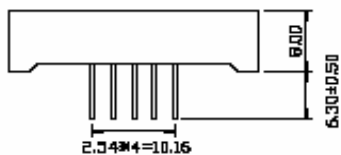
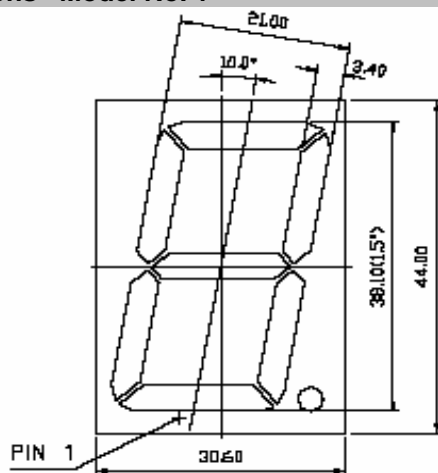
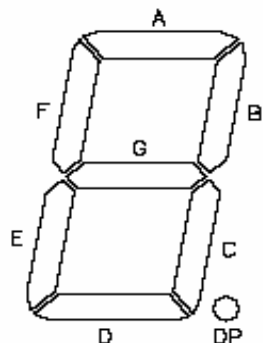

## Package Dimensions & Internal Circuit Diagramm

### Diode Drive Code A

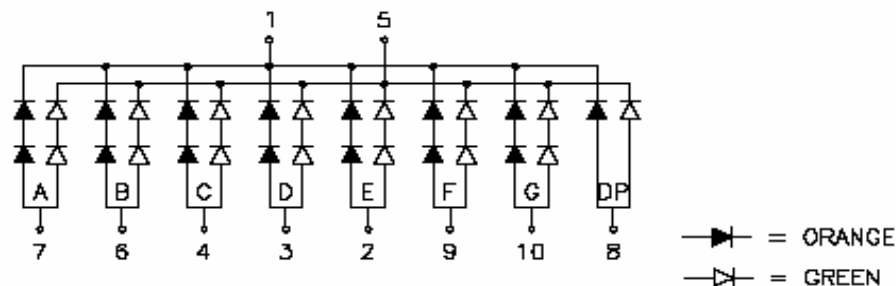

### Diode Drive Code B

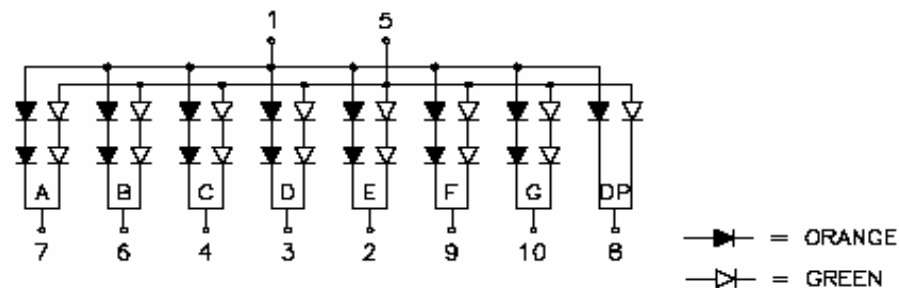

## Features

- Low Current Operation
- Excellent Character appearance
- Easy mounting on P.C. Board or Sockets
- Standard Brightness / Ultra Brightness

All Dimensions are in millimeters (inches).  
Tolerance is +/- 0,25 (0,01") unless otherwise specified.  
Specifications are subject to change without notice.

**Segment Display Digit  
Height 38,10mm**

Part No.: **M21A1082**

DRW:	Jason	CHKD	Wilson	MATL:	Wilson	TOLERANCE	Mason	DATE	30.09.2010	Customer:
APPD:	Schumi			FINISH	Jamy		Sheet No.	1 from 6		

[www.edcon-components.com](http://www.edcon-components.com)

email: [info@edcon-components.com](mailto:info@edcon-components.com)

# EDCON-COMPONENTS

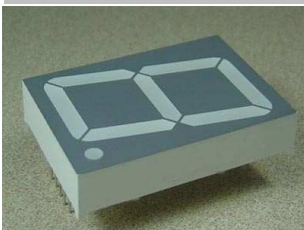

The Power of LED Light



## Description

Emitting Order Code (nm)	Emitting Color	Dice Material	Peak Wave Length	Spectral Line Width	Forward Voltage (VF)		Luminous Intensity (Iv) Unit: mcd
					Unit:V	Unit:V	
700A	Red	GaP	700nm	90nm	2,20	2,50	5,0
660A	Hi Red	AlGaAs, (A)	660nm	20nm	1,80	2,20	15~20
660B	Super Red	AlGaAs, (B)	660nm	20nm	1,80	2,20	20~30
660C	Ultra Red	AlGaAs, (C)	660nm	20nm	1,90	2,40	26~38
640A	High Efficiency Red	GaAsP	640nm	45nm	1,90	2,40	50~80
630A	Orange	GaAsP	630nm	35nm	2,10	2,50	10~20
610A	Amber	GaAsP	610nm	35nm	2,10	2,50	15~20
590A	Yellow	GaAsP	590nm	35nm	2,10	2,50	15~20
570A	Green	GaP	570nm	30nm	2,10	2,50	14~18
645U	Ultra Hi Red	AlGaInP	645nm	20nm	2,10	2,50	80~50
630U	Ultra Orange	AlGaInP	630nm	20nm	2,10	2,50	180~120
610U	Ultra Amber	AlGaInP	610nm	20nm	2,10	2,50	90~120
590U	Ultra Yellow	AlGaInP	590nm	20nm	2,10	2,50	150~200
570U	Ultra Green	AlGaInP	570nm	30nm	2,20	2,50	60~100
520U	Ultra Pure Green	InGaN	520nm	36nm	2,80	3,80	260~310
505U	Ultra Blue Green	InGaN	505nm	36nm	2,80	3,80	260~310
430U	Blue	InGaN	430nm	30nm	2,80	3,80	10~20
470U	Ultra Blue Green	InGaN	470nm	30nm	2,80	3,80	80~90
405U	UViolett	InGaN	405nm		2,80	3,80	5~8
2930	White	InGaN	X=0,29 / Y=0,30		2,80	3,80	180~200
2931	Ultra White	InGaN	X=0,29 / Y=0,30		2,80	3,80	180~200

Color Code & Chip Characteristics: Test conditions: IF=20mA

**Segment Display Digit  
Height 38,10mm**

Part No.: **M21A1082**

DRW:	Jason	CHKD	Wilson	MATL:	Wilson	TOLERANCE	Mason	DATE	30.09.2010
APPD:	Schumi			FINISH	Jamy		Sheet No.		2 from 6

Customer:

# EDCON-COMPONENTS

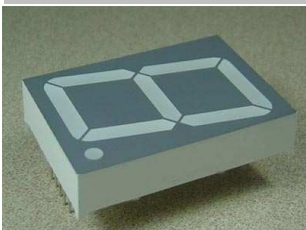

The Power of LED Light



## Characteristics

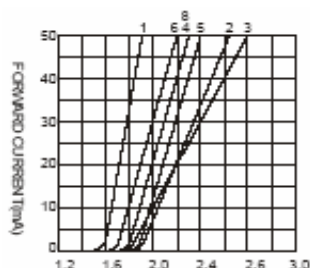

FORWARD VOLTAGE (V)  
FORWARD CURRENT VS.  
FORWARD VOLTAGE

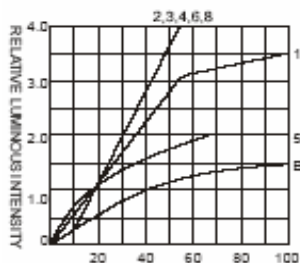

FORWARD CURRENT (mA)  
RELATIVE LUMINOUS  
INTENSITY VS. FORWARD  
CURRENT

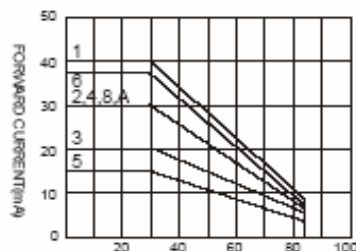

AMBIENT TEMPERATURE T<sub>a</sub> (°C)  
FORWARD CURRENT VS. AMBIENT  
TEMPERATURE

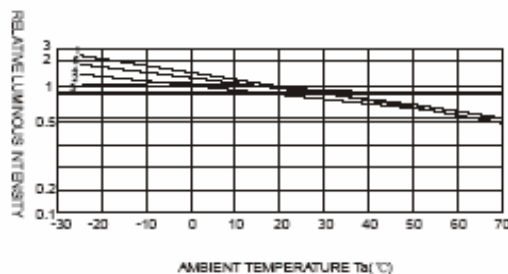
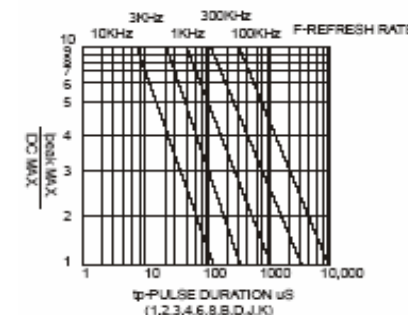
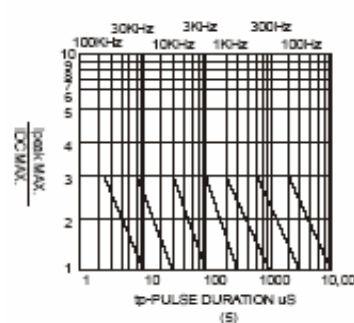

Note: 25°C free air temperature unless otherwise specified

**Segment Display Digit  
Height 38,10mm**

Part No.: **M21A1082**

DRW:	Jason	CHKD	Wilson	MATL:	Wilson	TOLERANCE	Mason	DATE	30.09.2010
APPD:	Schumi			FINISH	Jamy		Sheet No.	3 from 6	Customer:

[www.edcon-components.com](http://www.edcon-components.com)

email: [info@edcon-components.com](mailto:info@edcon-components.com)

# EDCON-COMPONENTS

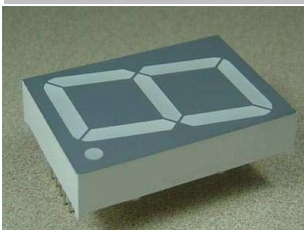

The Power of LED Light



## Characteristics

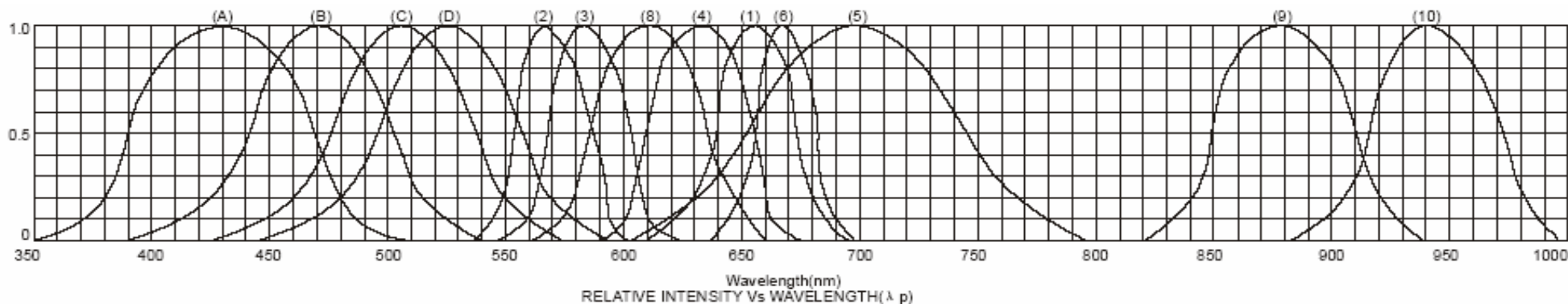

- |   |                                  |
|---|----------------------------------|
| 1 GaAsPI/GaAs 655nm Red                 | 9 GaAIAs 880nm                   |
| 2 GaP 570nm / Yellow Green              | 10 GaAs/GaAs & GaAiAs/GaAs 940nm |
| 3 GaAsP/GaP 585nm / Yellow              | A GaN/SiC 430nm Blue             |
| 4 GaAsP/GaP 635nm / Orange & Hi Eff Red | B InGaN/SiC 470nm Blue           |
| 5 GaP 700nm Bright /Red                 | C InGaN/SiC 505nm Ultra Green    |
| 6 GaAIAs/GaAs 660nm / Super Red         | D InGaN/SiC 525nm Ultra Green    |
| 8 GaAsPI/GaP 610nm / Super Red          |                                  |

Parameter	Symbol	Test Conditions	Value		Unit
			Min	Max	
Reverse Voltage	VR	IR=30μA	5	----	V
Forward Voltage	IF	----	----	30	mA
Power Dissipation	Pd	----	----	100	mW
Pulse Current	Ipeak	Duty= 0,1mS 1KHZ	----	150	mA
Operating Temperature	Topr	----	-40	+85	°C
Storage Temperature	Tstr	----	-40	+85	°C

Absolute maximum ratings (Ta=25°C)

**Segment Display Digit  
Height 38,10mm**

Part No.: **M21A1082**

DRW:	Jason	CHKD	Wilson	MATL:	Wilson	TOLERANCE	Mason	DATE	30.09.2010	Customer:
APPD:	Schumi			FINISH	Jamy		Sheet No.		4 from 6	

# EDCON-COMPONENTS

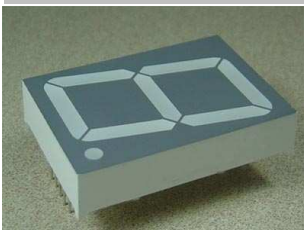

The Power of LED Light



## Ordering Informations

Serie	Digit Height Code	Quantity of Digits	Model Number	Diode Drive Code	Emitting Color (nm)	Surface Color Code	Segment Color Code	Lead Length Code	ROHS	Package
-------	-------------------	--------------------	--------------	------------------	---------------------	--------------------	--------------------	------------------	------	---------

<b>M21A1082</b>	<b>150</b>	<b>1</b>	<b>1</b>	<b>A</b>	<b>ORGN</b>	<b>2</b>	<b>1</b>	<b>62</b>	<b>R</b>	<b>Y</b>
-----------------	------------	----------	----------	----------	-------------	----------	----------	-----------	----------	----------

<b>150</b> = 0,150" Digit Dimension	<b>1</b> = Single Digit	<b>1</b> = Model Number 1	<b>A</b> = Commun Cathode			<b>0</b> = White Surface	<b>0</b> = Water Clear	<b>62</b> = Lead Length 6,2mm <b>xx</b> = Lead length Specified	<b>R</b> = ROHS conform <b>N</b> = NON ROHS conform	<b>Y</b> = Tray Packing (Standard) <b>U</b> = Tube Packing on Request
					<b>1</b> = Black Surface	<b>1</b> = White Diffused				
					<b>2</b> = Gray Surface	<b>2</b> = Red Diffused				
			<b>B</b> = Commun Anode		<b>3</b> = Red Surface	<b>3</b> = Green Diffused				
						<b>4</b> = Green Surface	<b>4</b> = Yellow Diffused			

<b>Segment Display Digit Height 38,10mm</b>
Part No.: <b>M21A1082</b>

DRW:	Jason	CHKD	Wilson	MATL:	Wilson	TOLERANCE	Mason	DATE	30.09.2010	Customer:
APPD:	Schumi			FINISH	Jamy			Sheet No.	5 from 6	

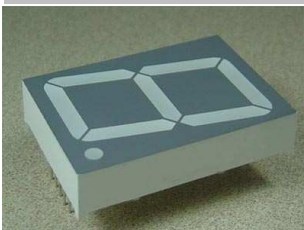

The Power of LED Light



Soldering Profile Curve

Classification Reflow Profile (JEDEC J-STD-020C)

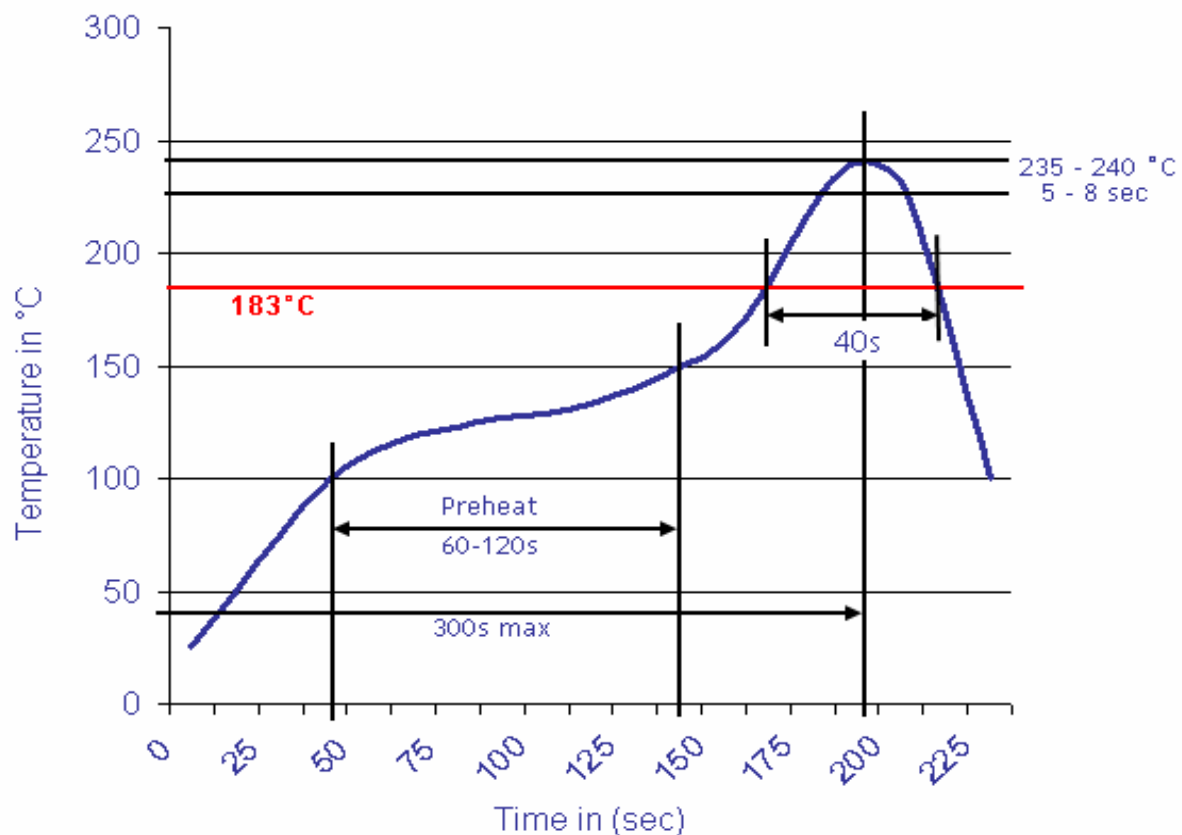

<b>Segment Display Digit Height 38,10mm</b>	
Part No.:	<b>M21A1082</b>
Customer:	

DRW:	Jason	CHKD	Wilson	MATL:	Wilson	TOLERANCE	Mason	DATE	30.09.2010
APPD:	Schumi			FINISH	Jamy		Sheet No.	6 from 6	