

EDCON-COMPONENTS

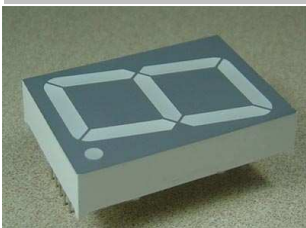

The Power of LED Light



Dimensions / Informations Model No. 1

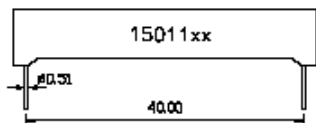
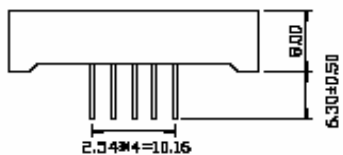
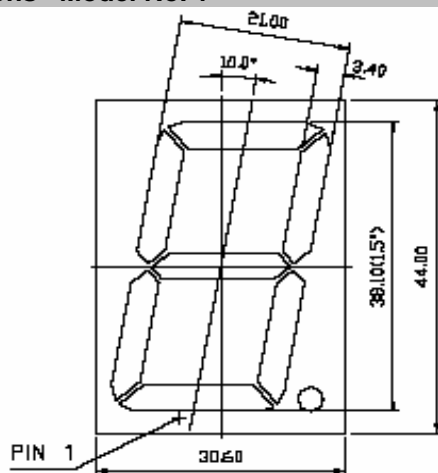
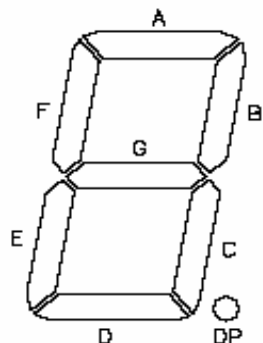

Package Dimensions & Internal Circuit Diagramm

Diode Drive Code A

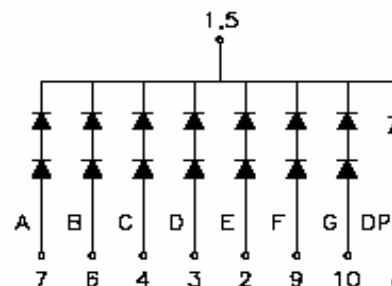

Diode Drive Code B

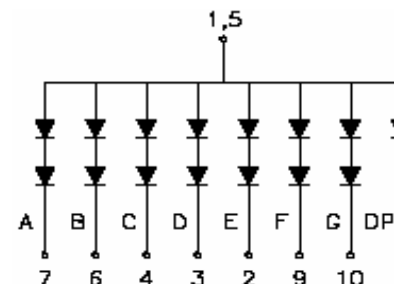

Features

- Low Current Operation
- Excellent Character appearance
- Easy mounting on P.C. Board or Sockets
- Standard Brightness / Ultra Brightness

All Dimensions are in millimeters (inches).
Tolerance is +/- 0,25 (0,01") unless otherwise specified.
Specifications are subject to change without notice.

**Segment Display Digit
Height 38,10mm**

Part No.: **M21A1080**

| | | | | | | | | | | |
|-------|--------|------|--------|--------|--------|-----------|-----------|----------|------------|-----------|
| DRW: | Jason | CHKD | Wilson | MATL: | Wilson | TOLERANCE | Mason | DATE | 30.09.2010 | Customer: |
| APPD: | Schumi | | | FINISH | Jamy | | Sheet No. | 1 from 6 | | |

www.edcon-components.com

email: info@edcon-components.com

EDCON-COMPONENTS

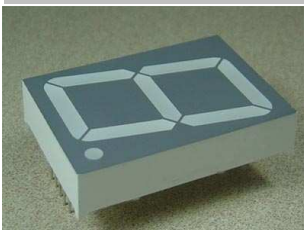

The Power of LED Light



Description

| Emitting Order Code (nm) | Emitting Color | Dice Material | Peak Wave Length | Spectral Line Width | Forward Voltage (VF) | | Luminous Intensity (Iv) Unit: mcd |
|--------------------------|---------------------|---------------|------------------|---------------------|----------------------|--------|-----------------------------------|
| | | | | | Unit:V | Unit:V | |
| 700A | Red | GaP | 700nm | 90nm | 2,20 | 2,50 | 5,0 |
| 660A | Hi Red | AlGaAs, (A) | 660nm | 20nm | 1,80 | 2,20 | 15~20 |
| 660B | Super Red | AlGaAs, (B) | 660nm | 20nm | 1,80 | 2,20 | 20~30 |
| 660C | Ultra Red | AlGaAs, (C) | 660nm | 20nm | 1,90 | 2,40 | 26~38 |
| 640A | High Efficiency Red | GaAsP | 640nm | 45nm | 1,90 | 2,40 | 50~80 |
| 630A | Orange | GaAsP | 630nm | 35nm | 2,10 | 2,50 | 10~20 |
| 610A | Amber | GaAsP | 610nm | 35nm | 2,10 | 2,50 | 15~20 |
| 590A | Yellow | GaAsP | 590nm | 35nm | 2,10 | 2,50 | 15~20 |
| 570A | Green | GaP | 570nm | 30nm | 2,10 | 2,50 | 14~18 |
| 645U | Ultra Hi Red | AlGaInP | 645nm | 20nm | 2,10 | 2,50 | 80~50 |
| 630U | Ultra Orange | AlGaInP | 630nm | 20nm | 2,10 | 2,50 | 180~120 |
| 610U | Ultra Amber | AlGaInP | 610nm | 20nm | 2,10 | 2,50 | 90~120 |
| 590U | Ultra Yellow | AlGaInP | 590nm | 20nm | 2,10 | 2,50 | 150~200 |
| 570U | Ultra Green | AlGaInP | 570nm | 30nm | 2,20 | 2,50 | 60~100 |
| 520U | Ultra Pure Green | InGaN | 520nm | 36nm | 2,80 | 3,80 | 260~310 |
| 505U | Ultra Blue Green | InGaN | 505nm | 36nm | 2,80 | 3,80 | 260~310 |
| 430U | Blue | InGaN | 430nm | 30nm | 2,80 | 3,80 | 10~20 |
| 470U | Ultra Blue Green | InGaN | 470nm | 30nm | 2,80 | 3,80 | 80~90 |
| 405U | UViolett | InGaN | 405nm | | 2,80 | 3,80 | 5~8 |
| 2930 | White | InGaN | X=0,29 / Y=0,30 | | 2,80 | 3,80 | 180~200 |
| 2931 | Ultra White | InGaN | X=0,29 / Y=0,30 | | 2,80 | 3,80 | 180~200 |

**Segment Display Digit
Height 38,10mm**

Part No.: **M21A1080**

| | | | | | | | | | |
|-------|--------|------|--------|--------|--------|-----------|-----------|------|------------|
| DRW: | Jason | CHKD | Wilson | MATL: | Wilson | TOLERANCE | Mason | DATE | 30.09.2010 |
| APPD: | Schumi | | | FINISH | Jamy | | Sheet No. | | 2 from 6 |

Customer:

EDCON-COMPONENTS

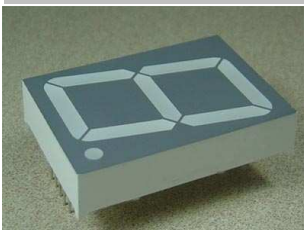

The Power of LED Light



Characteristics

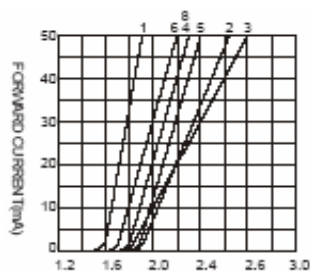

FORWARD VOLTAGE (V)
FORWARD CURRENT VS.
FORWARD VOLTAGE

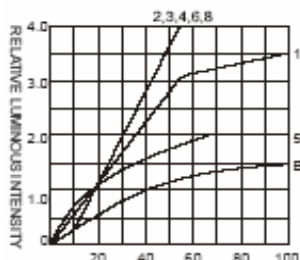

FORWARD CURRENT (mA)
RELATIVE LUMINOUS
INTENSITY VS. FORWARD
CURRENT

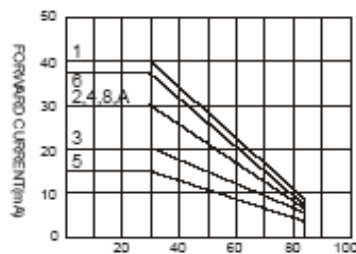

AMBIENT TEMPERATURE T_a (°C)
FORWARD CURRENT VS. AMBIENT
TEMPERATURE

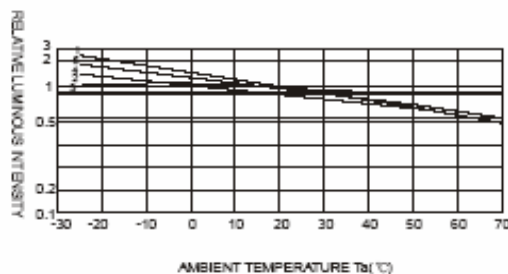
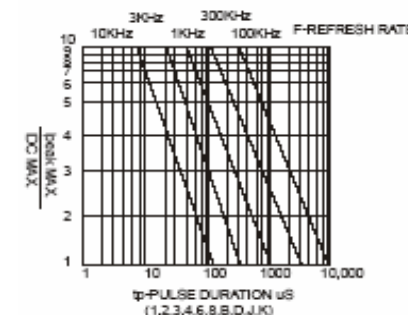
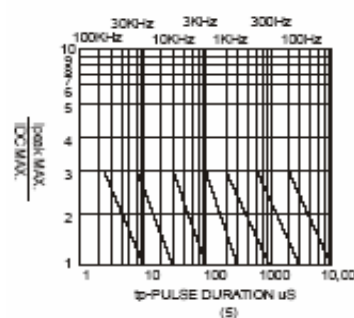

Note: 25°C free air temperature unless otherwise specified

**Segment Display Digit
Height 38,10mm**

Part No.: **M21A1080**

| | | | | | | | | | |
|-------|--------|------|--------|--------|--------|-----------|-----------|----------|------------|
| DRW: | Jason | CHKD | Wilson | MATL: | Wilson | TOLERANCE | Mason | DATE | 30.09.2010 |
| APPD: | Schumi | | | FINISH | Jamy | | Sheet No. | 3 from 6 | Customer: |

www.edcon-components.com

email: info@edcon-components.com

EDCON-COMPONENTS

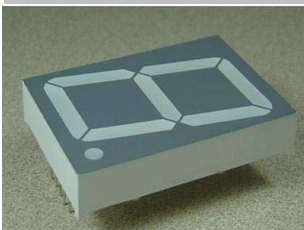

The Power of LED Light



Characteristics

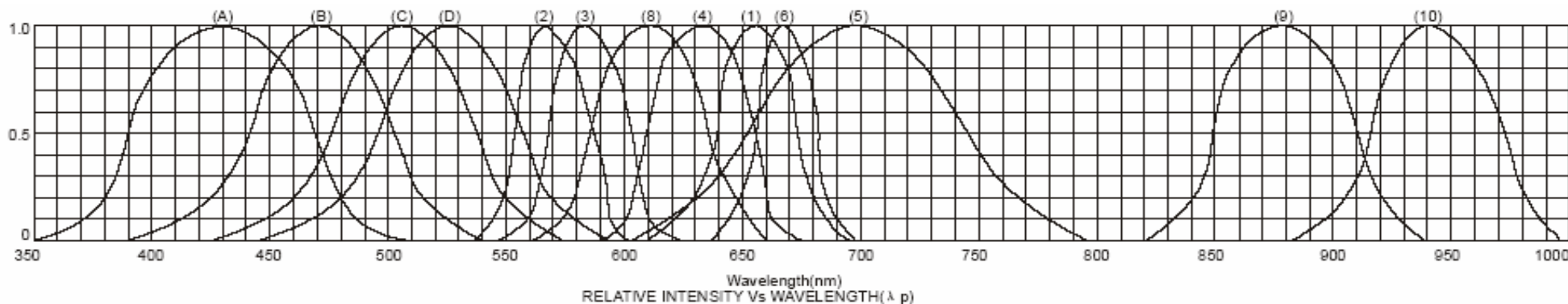

- | | |
|---|----------------------------------|
| 1 GaAsPI/GaAs 655nm Red | 9 GaAIAs 880nm |
| 2 GaP 570nm / Yellow Green | 10 GaAs/GaAs & GaAiAs/GaAs 940nm |
| 3 GaAsP/GaP 585nm / Yellow | A GaN/SiC 430nm Blue |
| 4 GaAsP/GaP 635nm / Orange & Hi Eff Red | B InGaN/SiC 470nm Blue |
| 5 GaP 700nm Bright /Red | C InGaN/SiC 505nm Ultra Green |
| 6 GaAIAs/GaAs 660nm / Super Red | D InGaN/SiC 525nm Ultra Green |
| 8 GaAsPI/GaP 610nm / Super Red | |

| Parameter | Symbol | Test Conditions | Value | | Unit |
|-----------------------|--------|------------------|-------|------|------|
| | | | Min | Max | |
| Reverse Voltage | VR | IR=30μA | 5 | ---- | V |
| Forward Voltage | IF | ---- | ---- | 30 | mA |
| Power Dissipation | Pd | ---- | ---- | 100 | mW |
| Pulse Current | Ipeak | Duty= 0,1mS 1KHZ | ---- | 150 | mA |
| Operating Temperature | Topr | ---- | -40 | +85 | °C |
| Storage Temperature | Tstr | ---- | -40 | +85 | °C |

Absolute maximum ratings (Ta=25°C)

**Segment Display Digit
Height 38,10mm**

Part No.: **M21A1080**

| | | | | | | | | | | |
|-------|--------|------|--------|--------|--------|-----------|-----------|----------|------------|-----------|
| DRW: | Jason | CHKD | Wilson | MATL: | Wilson | TOLERANCE | Mason | DATE | 30.09.2010 | Customer: |
| APPD: | Schumi | | | FINISH | Jamy | | Sheet No. | 4 from 6 | | |

EDCON-COMPONENTS

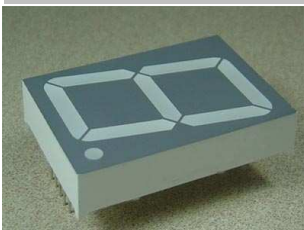

The Power of LED Light



Ordering Informations

| Serie | Digit Height Code | Quantity of Digits | Model Number | Diode Drive Code | Emitting Color (nm) | Surface Color Code | Segment Color Code | Lead Length Code | ROHS | Package |
|-----------------|-------------------|--------------------|--------------|------------------|---------------------|--------------------|--------------------|------------------|----------|----------|
| M21A1080 | 150 | 1 | 1 | A | 700A | 2 | 1 | 62 | R | Y |

| | | | | | | | | | | | | | | | | | | | | | | |
|--|-----------------------------|-----------------------------|-----------------------------|---------------------------|----------------------------------|----------------------------|--------------------------|------------------------------------|---------------------------|---|----------------------------|-----------------------------|--|----------------------------------|---|---------------------------|---------------------------|--------------------------|-----------------------------|----------------------------|------------------------------|-----------------------------|
| 150= 0,150" Digit Dimension | 1= Single Digit | 1= Model Number 1 | A= Commun Cathode | Standard | Ultra Brightn | 0= White Surface | 0= Water Clear | 62= Lead Length 6,2mm | R= ROHS conform | Y= Tray Packing (Standard) | | | | | | | | | | | | |
| | | | | 700A= Red | 645U= Hi Red | | | | | | 1= Black Surface | 1= White Diffused | xx= Lead length Specified | N= NON ROHS conform | U= Tube Packing on Request | | | | | | | |
| | | | | 660A= Hi Red | 630U= Ultra Orange | | | | | | | | | | | 2= Gray Surface | 2= Red Diffused | | | | | |
| | | | | 660B= Super Red | 610U= Ultra Amber | | | | | | | | | | | | | 3= Red Surface | 3= Green Diffused | | | |
| | | | | 660C= Ultra Red | 590U= Ultra Yellow | | | | | | | | | | | | | | | 4= Green Surface | 4= Yellow Diffused | |
| | | | | B= Commun Anode | 640A= HE Red | | | | | | | | | | | | | | | | | 570U= Ultra Green |
| | | | | 630A= Orange | 520U= Ultra Pure Green | | | | | | | | | | | | | | | | | |
| | | | | 610A= Amber | 505U= Ultra Blue Green | | | | | | | | | | | | | | | | | |
| | | | | 590A= Yellow | 470U= Ultra Blue | | | | | | | | | | | | | | | | | |
| | | | | 570A= Green | 430U= Blue | | | | | | | | | | | | | | | | | |
| 405U= Ultra Violett | 2931= Ultra White | | | | | | | | | | | | | | | | | | | | | |

**Segment Display Digit
Height 38,10mm**

Part No.: **M21A1080**

| | | | | | | | | | | |
|-------|--------|------|--------|--------|--------|-----------|-----------|----------|------------|-----------|
| DRW: | Jason | CHKD | Wilson | MATL: | Wilson | TOLERANCE | Mason | DATE | 30.09.2010 | Customer: |
| APPD: | Schumi | | | FINISH | Jamy | | Sheet No. | 5 from 6 | | |

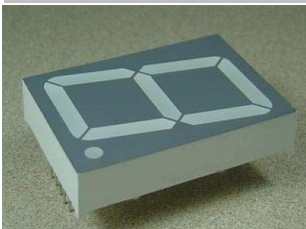

The Power of LED Light



Soldering Profile Curve

Classification Reflow Profile (JEDEC J-STD-020C)

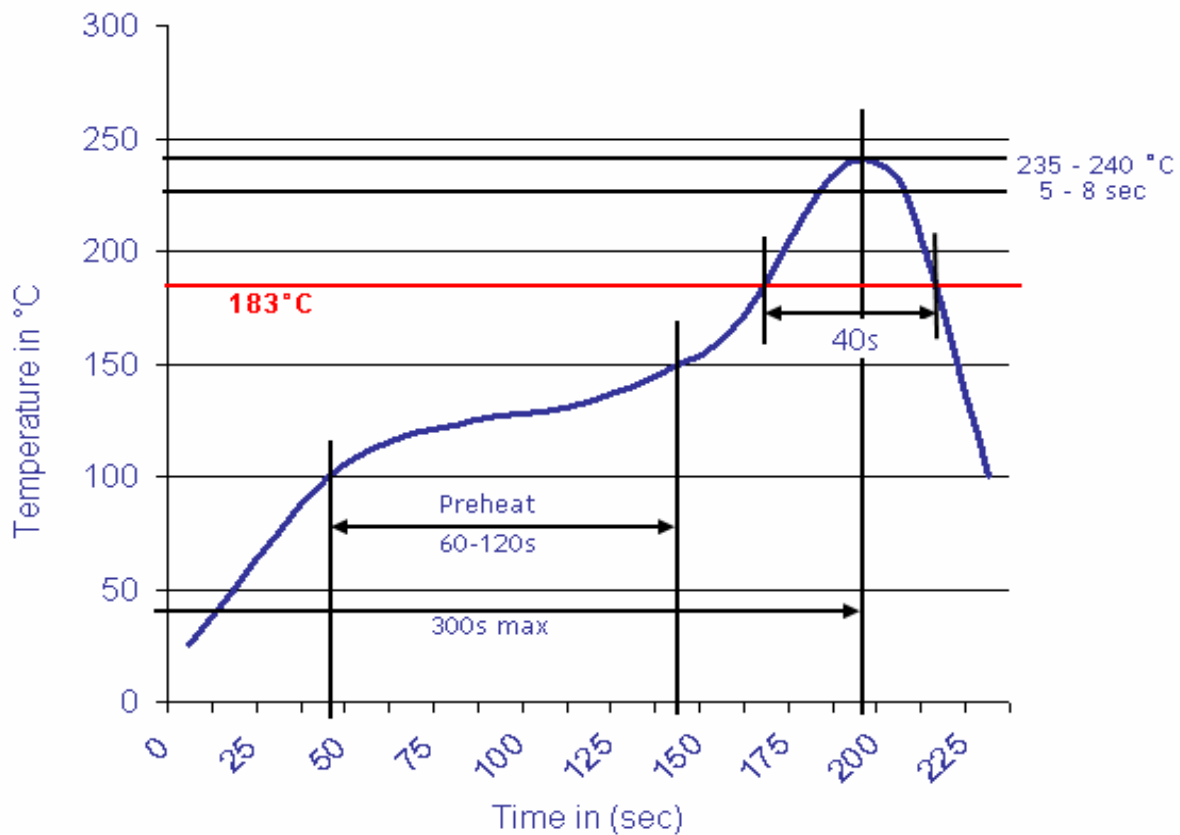

**Segment Display Digit
Height 38,10mm**

Part No.: **M21A1080**

| | | | | | | | | | |
|-------|--------|------|--------|--------|--------|-----------|-----------|----------|------------|
| DRW: | Jason | CHKD | Wilson | MATL: | Wilson | TOLERANCE | Mason | DATE | 30.09.2010 |
| APPD: | Schumi | | | FINISH | Jamy | | Sheet No. | 6 from 6 | Customer: |